

**ASUS<sup>®</sup> P3B-F**  
Pentium<sup>®</sup> III / II / Celeron<sup>™</sup>  
Motherboard

**USER'S MANUAL**

# USER'S NOTICE

---

No part of this manual, including the products and software described in it, may be reproduced, transmitted, transcribed, stored in a retrieval system, or translated into any language in any form or by any means, except documentation kept by the purchaser for backup purposes, without the express written permission of ASUSTeK COMPUTER INC. ("ASUS").

ASUS PROVIDES THIS MANUAL "AS IS" WITHOUT WARRANTY OF ANY KIND, EITHER EXPRESS OR IMPLIED, INCLUDING BUT NOT LIMITED TO THE IMPLIED WARRANTIES OR CONDITIONS OF MERCHANTABILITY OR FITNESS FOR A PARTICULAR PURPOSE. IN NO EVENT SHALL ASUS, ITS DIRECTORS, OFFICERS, EMPLOYEES OR AGENTS BE LIABLE FOR ANY INDIRECT, SPECIAL, INCIDENTAL, OR CONSEQUENTIAL DAMAGES (INCLUDING DAMAGES FOR LOSS OF PROFITS, LOSS OF BUSINESS, LOSS OF USE OR DATA, INTERRUPTION OF BUSINESS AND THE LIKE), EVEN IF ASUS HAS BEEN ADVISED OF THE POSSIBILITY OF SUCH DAMAGES ARISING FROM ANY DEFECT OR ERROR IN THIS MANUAL OR PRODUCT.

Product warranty or service will not be extended if: (1) the product is repaired, modified or altered, unless such repair, modification or alteration is authorized in writing by ASUS; or (2) the serial number of the product is defaced or missing.

Products and corporate names appearing in this manual may or may not be registered trademarks or copyrights of their respective companies, and are used only for identification or explanation and to the owners' benefit, without intent to infringe.

- QuickStart and JumperFree are trademarks of ASUSTeK Computer Incorporated.
- Intel, LANDesk, and Pentium are registered trademarks of Intel Corporation.
- Celeron is a trademark of Intel Corporation.
- IBM and OS/2 are registered trademarks of International Business Machines.
- Symbios is a registered trademark of Symbios Logic Corporation.
- Windows and MS-DOS are registered trademarks of Microsoft Corporation.
- Adobe and Acrobat are registered trademarks of Adobe Systems Incorporated.

The product name and revision number are both printed on the product itself. Manual revisions are released for each product design represented by the digit before and after the period of the manual revision number. Manual updates are represented by the third digit in the manual revision number.

For previous or updated manuals, BIOS, drivers, or product release information, contact ASUS at <http://www.asus.com.tw> or through any of the means indicated on the following page.

SPECIFICATIONS AND INFORMATION CONTAINED IN THIS MANUAL ARE FURNISHED FOR INFORMATIONAL USE ONLY, AND ARE SUBJECT TO CHANGE AT ANY TIME WITHOUT NOTICE, AND SHOULD NOT BE CONSTRUED AS A COMMITMENT BY ASUS. ASUS ASSUMES NO RESPONSIBILITY OR LIABILITY FOR ANY ERRORS OR INACCURACIES THAT MAY APPEAR IN THIS MANUAL, INCLUDING THE PRODUCTS AND SOFTWARE DESCRIBED IN IT.

**Copyright © 1999 ASUSTeK COMPUTER INC. All Rights Reserved.**

Product Name: **ASUS P3B-F**  
Manual Revision: **1.01 E427**  
Release Date: **July 1999**

# ASUS CONTACT INFORMATION

---

## ASUSTeK COMPUTER INC. (Asia-Pacific)

### *Marketing*

Address: 150 Li-Te Road, Peitou, Taipei, Taiwan 112  
Telephone: +886-2-2894-3447  
Fax: +886-2-2894-3449  
Email: info@asus.com.tw

### *Technical Support*

MB/Cards (tel): English: +886-2-2890-7121      Chinese: +886-2-2890-7111  
Notebook (tel): English: +886-2-2890-7122      Chinese: +886-2-2890-7112  
Server (tel): English: +886-2-2890-7123      Chinese: +886-2-2890-7113  
Fax: +886-2-2895-9254  
Email: tsd@asus.com.tw  
Newsgroup: news2.asus.com.tw  
WWW: www.asus.com.tw  
FTP: ftp.asus.com.tw/pub/ASUS

## ASUS COMPUTER INTERNATIONAL (America)

### *Marketing*

Address: 6737 Mowry Avenue, Mowry Business Center, Building 2  
Newark, CA 94560, USA  
Fax: +1-510-608-4555  
Email: info-usa@asus.com.tw

### *Technical Support*

Fax: +1-510-608-4555  
BBS: +1-510-739-3774  
Email: tsd@asus.com  
WWW: www.asus.com  
FTP: ftp.asus.com.tw/pub/ASUS

## ASUS COMPUTER GmbH (Europe)

### *Marketing*

Address: Harkort Str. 25, 40880 Ratingen, BRD, Germany  
Telephone: MB/Other: +49-2102-9599-0      Notebook: +49-2102-9599-10  
Fax: +49-2102-9599-11  
Email: info@asuscom.de

### *Technical Support*

Hotline: MB/Other: +49-2102-9599-0      Notebook: +49-2102-9599-10  
Email: tsd@asuscom.de  
WWW: www.asuscom.de  
FTP: ftp.asuscom.de/pub/ASUSCOM

# CONTENTS

---

<b>1. INTRODUCTION .....</b>	<b>7</b>
1.1 How this Manual is Organized .....	7
1.2 Item Checklist .....	7
<b>2. FEATURES .....</b>	<b>8</b>
2.1 The ASUS P3B-F Motherboard .....	8
2.1.1 Specifications .....	8
2.1.2 Special Features .....	10
2.1.3 Performance Features .....	10
2.1.4 Intelligence .....	11
2.2 ASUS P3B-F Motherboard Parts .....	12
<b>3. HARDWARE SETUP .....</b>	<b>14</b>
3.1 Motherboard Layout .....	14
3.2 Layout Contents .....	15
3.3 Hardware Setup Procedure .....	16
3.4 Motherboard Settings .....	16
3.5 System Memory (DIMM) .....	21
3.5.1 General DIMM Notes .....	21
3.5.2 DIMM Memory Installation .....	22
3.6 Central Processing Unit (CPU) .....	23
3.6.1 Universal Retention Mechanism .....	23
3.6.2 Heatsinks .....	24
3.6.3 Installing the Processor .....	24
3.6.4 Recommended Heatsinks for Slot 1 Processors .....	27
3.7 Expansion Cards .....	28
3.7.1 Expansion Card Installation Procedure .....	28
3.7.2 Assigning IRQs for Expansion Cards .....	28
3.7.3 Assigning DMA Channels for ISA Cards .....	29
3.7.4 Accelerated Graphics Port (AGP) .....	29
3.8 External Connectors .....	30
3.9 Power Connection Procedures .....	39
<b>4. BIOS SETUP .....</b>	<b>40</b>
4.1 Managing and Updating Your BIOS .....	40
4.1.1 Upon First Use of the Computer System .....	40
4.1.2 Updating BIOS Procedures (only when necessary) .....	41

# CONTENTS

---

4.2	BIOS Setup Program .....	43
4.2.1	BIOS Menu Bar .....	44
4.2.2	Legend Bar .....	44
4.3	Main Menu .....	46
4.3.1	Primary & Secondary Master/Slave .....	47
4.4	Advanced Menu .....	52
4.4.1	Chip Configuration .....	54
4.4.2	I/O Device Configuration .....	56
4.4.3	PCI Configuration .....	58
4.4.4	Shadow Configuration .....	61
4.5	Power Menu .....	62
4.5.1	Power Up Control .....	64
4.5.2	Hardware Monitor .....	66
4.6	Boot Menu .....	67
4.7	Exit Menu .....	69
<b>5.</b>	<b>SOFTWARE SETUP .....</b>	<b>71</b>
5.1	Operating Systems .....	71
5.2	P3B-F Support CD .....	71
5.3	Intel LDCM Administrator Setup .....	73
5.4	Intel LDCM Client Setup .....	74
5.5	Install ASUS PC Probe Vx.xx .....	76
5.6	Install ASUS Update Vx.xx .....	77
5.7	Install PC-Cillin 98 Vx.xx .....	78
5.8	Install ADOBE AcroBat Reader Vx.x .....	79
5.9	Uninstalling Programs .....	80
<b>6.</b>	<b>SOFTWARE REFERENCE .....</b>	<b>81</b>
6.1	Intel LANDesk Client Manager .....	81
6.2	ASUS PC Probe .....	87
<b>7.</b>	<b>APPENDIX .....</b>	<b>93</b>
7.1	PCI-L101 Fast Ethernet Card .....	93
7.2	S370 Series CPU Transform Card .....	95

# FCC & DOC COMPLIANCE

---

## ***Federal Communications Commission Statement***

This device complies with FCC Rules Part 15. Operation is subject to the following two conditions:

- This device may not cause harmful interference, and
- This device must accept any interference received, including interference that may cause undesired operation.

This equipment has been tested and found to comply with the limits for a Class B digital device, pursuant to Part 15 of the FCC Rules. These limits are designed to provide reasonable protection against harmful interference in a residential installation. This equipment generates, uses and can radiate radio frequency energy and, if not installed and used in accordance with manufacturer's instructions, may cause harmful interference to radio communications. However, there is no guarantee that interference will not occur in a particular installation. If this equipment does cause harmful interference to radio or television reception, which can be determined by turning the equipment off and on, the user is encouraged to try to correct the interference by one or more of the following measures:

- Re-orient or relocate the receiving antenna.
- Increase the separation between the equipment and receiver.
- Connect the equipment to an outlet on a circuit different from that to which the receiver is connected.
- Consult the dealer or an experienced radio/TV technician for help.

**WARNING!** Any changes or modifications to this product not expressly approved by the manufacturer could void any assurances of safety or performance and could result in violation of Part 15 of the FCC Rules.

Reprinted from the Code of Federal Regulations #47, part 15.193, 1993. Washington DC: Office of the Federal Register, National Archives and Records Administration, U.S. Government Printing Office.

## ***Canadian Department of Communications Statement***

This digital apparatus does not exceed the Class B limits for radio noise emissions from digital apparatus set out in the Radio Interference Regulations of the Canadian Department of Communications.

**This Class B digital apparatus complies with Canadian ICES-003.**

**Cet appareil numérique de la classe B est conforme à la norme NMB-003 du Canada.**

# 1. INTRODUCTION

## 1.1 How this Manual is Organized

This manual is divided into the following sections:

- |                              |  |
|------------------------------|--|
| 1. <b>Introduction</b>       | Manual information and checklist                         |
| 2. <b>Features</b>           | Information and specifications concerning this product   |
| 3. <b>Hardware Setup</b>     | Instructions on setting up the motherboard and jumpers   |
| 4. <b>BIOS Setup</b>         | Instructions on setting up the BIOS software             |
| 5. <b>Software Setup</b>     | Instructions on setting up the included support software |
| 6. <b>Software Reference</b> | Reference material for the included support software     |
| 7. <b>Appendix</b>           | Optional items and general reference                     |

## 1.2 Item Checklist

Please check that your package is complete. If you discover damaged or missing items, please contact your retailer.

- (1) ASUS Motherboard
- (1) Universal Retention Mechanism for SECC2/SECC/SEPP processors
- (1) Ribbon cable for master and slave IDE drives
- (1) Ribbon cable for (1) 5.25" and (2) 3.5" floppy drives
- (1) Bag of spare jumper caps
- (1) Support CD with drivers and utilities
- (1) This Motherboard User's Manual
- ASUS IrDA-compliant infrared module (optional)
- ASUS S370 Series CPU transform card (optional)
- ASUS PCI-L101 Wake-On-LAN 10/100 Ethernet Card (optional)

## 2. FEATURES

---

### 2.1 The ASUS P3B-F Motherboard

The ASUS P3B-F is carefully designed for the demanding PC user who wants advanced features processed by the fastest CPU.

#### 2.1.1 Specifications

- **Multi-Speed:** Supports Intel Pentium® III (450MHz and faster), Pentium® II (233MHz to 450MHz), and Celeron™ (266MHz and faster) processors.
- **Intel AGPset:** Features Intel's 440BX AGPset with I/O subsystems and front-side bus (FSB) platform, which boosts the traditional 66MHz external bus speed to 100MHz.
- **Multi-Cache:** Supports processors with 512, 256, 128, or 0KB Pipelined Burst Level 2 cache.
- **PC100 Memory Support:** Equipped with four DIMM sockets to support Intel PC100-compliant SDRAMs (8, 16, 32, 64, 128, or 256MB) up to 1024MB. These new SDRAMs are necessary to meet the critical enhanced 100MHz bus speed requirement.
- **JumperFree™ BIOS:** Allows processor settings and easy overclocking of frequency and Vcore voltages all through BIOS setup when JumperFree™ mode is enabled. Easy-to-use DIP switches instead of jumpers are provided to manually setup the processor.
- **Smart BIOS:** 2Mb firmware provides Vcore and CPU/SDRAM frequency adjustments, boot block write protection, and HD/SCSI/MO/ZIP/CD/Floppy boot selection. Power supply is autodetected to enable/disable suspend-to-RAM and KB/PS/2 mouse power up, eliminating the need to make jumper adjustments.
- **Multi-device Wake Up:** Supports modem wake up, keyboard/PS/2 mouse wake up, and LAN card wake up functions from sleep or soft-off mode.
- **PC Health Monitoring:** Provides an easier way to examine and manage system status information, such as CPU and system voltages, temperatures, and fan status through the onboard hardware ASIC and the bundled LDCM from Intel or PC Probe from ASUS.
- **Enhanced ACPI & Anti-Boot Virus Protection:** Programmable BIOS (flash EEPROM), offering enhanced ACPI for Windows 98 compatibility, built-in firmware-based virus protection, and autodetection of most devices for virtually automatic setup.
- **AGP Slot:** Supports an Accelerated Graphics Port card for high performance, component level interconnect targeted at 3D graphical display applications using a 1X or 2X mode bus.
- **SMBus:** Features the System Management Bus interface, which is used to physically transport commands and information between SMBus devices.



## 2. FEATURES

---

- **PCI & ISA Expansion Slots:** Provides options of five 32-bit PCI (rev 2.2) with two 16-bit ISA expansion slots, six PCI with one ISA, and six PCI with no ISA. All PCI slots can support Bus Master PCI cards, such as SCSI or LAN cards. (PCI supports up to 133MB/s maximum throughput.)
- **Multi-I/O:** Provides two high-speed UART compatible serial ports and one parallel port with EPP and ECP capabilities. UART2 can also be directed from COM2 to the Infrared Module for wireless connections.
- **UltraDMA/33 Bus Master IDE:** Comes with an onboard PCI Bus Master IDE controller with two connectors that support four IDE devices in two channels. Supports UltraDMA/33, PIO Modes 3 and 4, and Bus Master IDE DMA Mode 2, as well as Enhanced IDE devices, such as Tape Backup, CD-ROM, CD-R/W, and LS-120 drives.
- **Universal Retention Mechanism:** Supports a Pentium® III / II processor packaged in a Single Edge Contact Cartridge (SECC2/SECC) or a Celeron™ processor packaged in a Single Edge Processor Package (SEPP).
- **Wake-On-LAN Connector:** Supports Wake-On-LAN activity through an optional ASUS PCI-L101 10/100 Fast Ethernet PCI card (see *7.1 PCI-L101 Fast Ethernet Card*) or a similar ethernet card.
- **Wake-On-Ring Connector:** Supports Wake-On-Ring activity through a PCI modem card which supports a WOR connector.
- **IrDA:** Supports an optional infrared port module for a wireless interface.
- **Onboard LED:** The onboard LED will light up when there is standby power to the PCI bus. This acts as a reminder to the user to turn OFF the power before plugging and unplugging devices so as not to damage the motherboard, peripherals, and/or components.

## 2. FEATURES

---

### 2.1.2 Special Features

- **ACPI Ready:** Advanced Configuration Power Interface (ACPI) provides more Energy Saving Features for operating systems that support OS Direct Power Management (OSPM) functionality. With these features implemented in the OS, PCs can be ready around the clock, yet satisfy all the energy saving standards. To fully utilize the benefits of ACPI, an ACPI-supported OS such as Windows 98 must be used.
- **Suspend and Go:** Suspend-to-RAM (STR) provides maximum power savings (average of 5 watts) as an alternative to leaving the computer ON and QuickStart™ so that you do not fall asleep waiting for system bootup (Suspend-to-RAM requires OS support and does not support ISA cards; ISA cards may fail to work coming out of STR mode).
- **Easy Installation:** Incorporates BIOS that supports autodetection of hard disk drives, PS/2 mouse, and Plug and Play devices to make the setup of hard disk drives, expansion cards, and other devices virtually automatic.
- **PC'99 Compliant:** Both the BIOS and hardware levels of ASUS smart series motherboards meet PC'99 compliancy. The new PC'99 requirements for systems and components are based on the following high-level goals: Support for Plug and Play compatibility and power management for configuring and managing all system components, and 32-bit device drivers and installation procedures for Windows 95/98/NT. Color-coded connectors and descriptive icons make identification easy as required by PC'99.
- **Symbios SCSI BIOS:** Supports optional ASUS SCSI controller cards through the onboard SYMBIOS firmware.

### 2.1.3 Performance Features

- **Concurrent PCI:** Concurrent PCI allows multiple PCI transfers from PCI master busses to the memory and processor.
- **Double the IDE Transfer Speed:** ASUS smart series motherboards with Intel chipsets improves IDE transfer rate using Bus Master UltraDMA/33 IDE which can handle data transfers up to 33MB/s.
- **SDRAM Optimized Performance:** Supports the new generation memory - Synchronous Dynamic Random Access Memory (SDRAM) which increases the data transfer rate to 800MB/s max using PC100-compliant SDRAM.

## 2. FEATURES

---

### 2.1.4 Intelligence

- **Auto Fan Off:** The system fans will power off automatically **even in sleep mode**. This function reduces both energy consumption and **system noise**, and is an important feature in implementing silent PC systems.
- **Dual Function Power Button:** Pushing the power button for less than 4 seconds when the system is in the working state places the system into one of two states: sleep mode or soft-off mode, depending on the BIOS or OS setting (see **PWR Button < 4 Secs** in **4.5 Power Menu**). When the power button is pressed for more than 4 seconds, the system enters the soft-off mode regardless of the BIOS setting.
- **Fan Status Monitoring and Alarm:** To prevent system overheat and system damage, the CPU, power supply, and system fans can be monitored for RPM and failure. All fans are set for its normal RPM range and alarm thresholds.
- **PS/2 Keyboard/Mouse Power Up:** Keyboard/Mouse Power Up can be enabled or disabled to allow the computer to be powered on by pressing the space bar on the keyboard or moving the mouse.
- **Message LED (requires ACPI OS support):** Turbo LEDs now act as information providers. Through the way a particular LED illuminates, the user can determine if there are messages waiting in the mailbox. A simple glimpse provides useful information to the user.
- **Remote Ring On (requires modem):** This allows a computer to be turned on remotely through an internal or external modem. With this benefit on-hand, users can access vital information from their computers from anywhere in the world!
- **System Resources Alert:** Today's operating systems such as Windows 95/98/NT and OS/2, require much more memory and hard drive space to present enormous user interfaces and run large applications. The system resource monitor will warn the user before the system resources are used up to prevent possible application crashes. Suggestions will give the user information on managing their limited resources more efficiently.
- **Temperature Monitoring and Alert:** CPU temperature is monitored by the ASUS ASIC through the CPU's internal thermal diode (on Pentium III, Deschutte Pentium II, and PPGA370 Celeron in conjunction with the ASUS S370-D or S370-L transform card) to prevent system overheat and system damage.
- **Voltage Monitoring and Alert:** System voltage levels are monitored to ensure stable voltage to critical motherboard components. Voltage specifications are more critical for future processors, so monitoring is necessary to ensure proper system configuration and management.
- **Chassis Intrusion Detection:** Supports chassis-intrusion monitoring through the ASUS ASIC. A chassis intrusion event is kept in memory on battery power for more protection.

## 2. FEATURES

---

### 2.2 ASUS P3B-F Motherboard Parts

- 1 ATX Power Connector
- 2 Slot 1 CPU Socket
- 3 Intel BX AGPset
- 4 4 DIMM Sockets
- 5 IDE Connectors
- 6 ASUS ASIC with hardware monitor
- 7 Floppy Disk Drive Connector
- 8 Function DIP Switches
- 9 Intel PIIX4E PCIset
- 10 Onboard LED
- 11 Wake-On-Ring Connector
- 12 1 or 2 ISA Slots (on ISA model only)
- 13 Programmable Flash EEPROM
- 14 Wake-On-LAN Connector
- 15 Multi I/O Chip
- 16 5 or 6 PCI Slots
- 17 Accelerated Graphics Port
- 18 Serial Port Connector
- 19 Parallel Port Connector
- 20 Serial Port Connector
- 21 2 USB Connectors
- 22 T: PS/2 Mouse Connector  
B: PS/2 Keyboard Connector

## 2. FEATURES

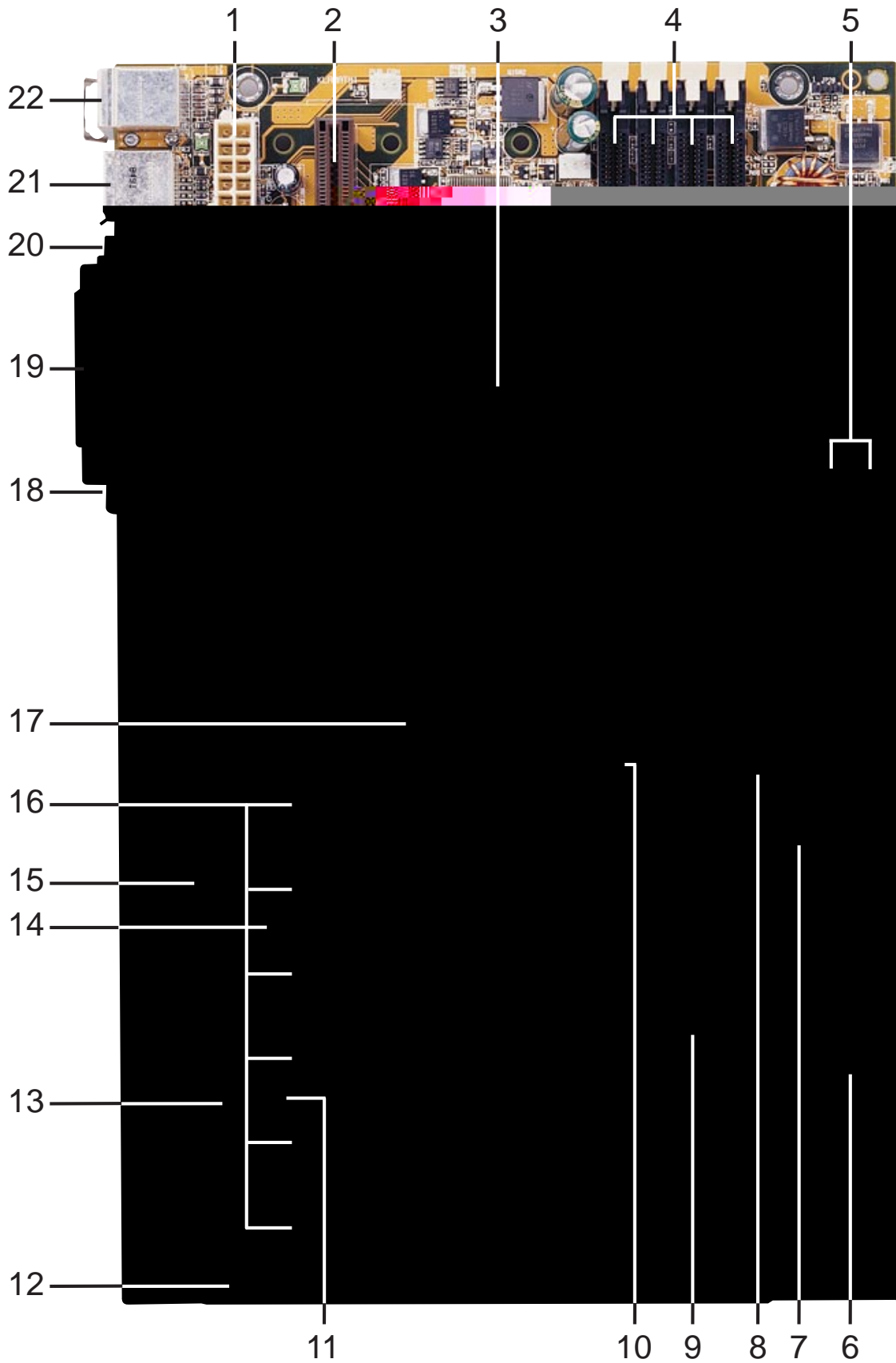

**2. FEATURES**  
Motherboard Parts

# 3. HARDWARE SETUP

---

## 3.1 Motherboard Layout

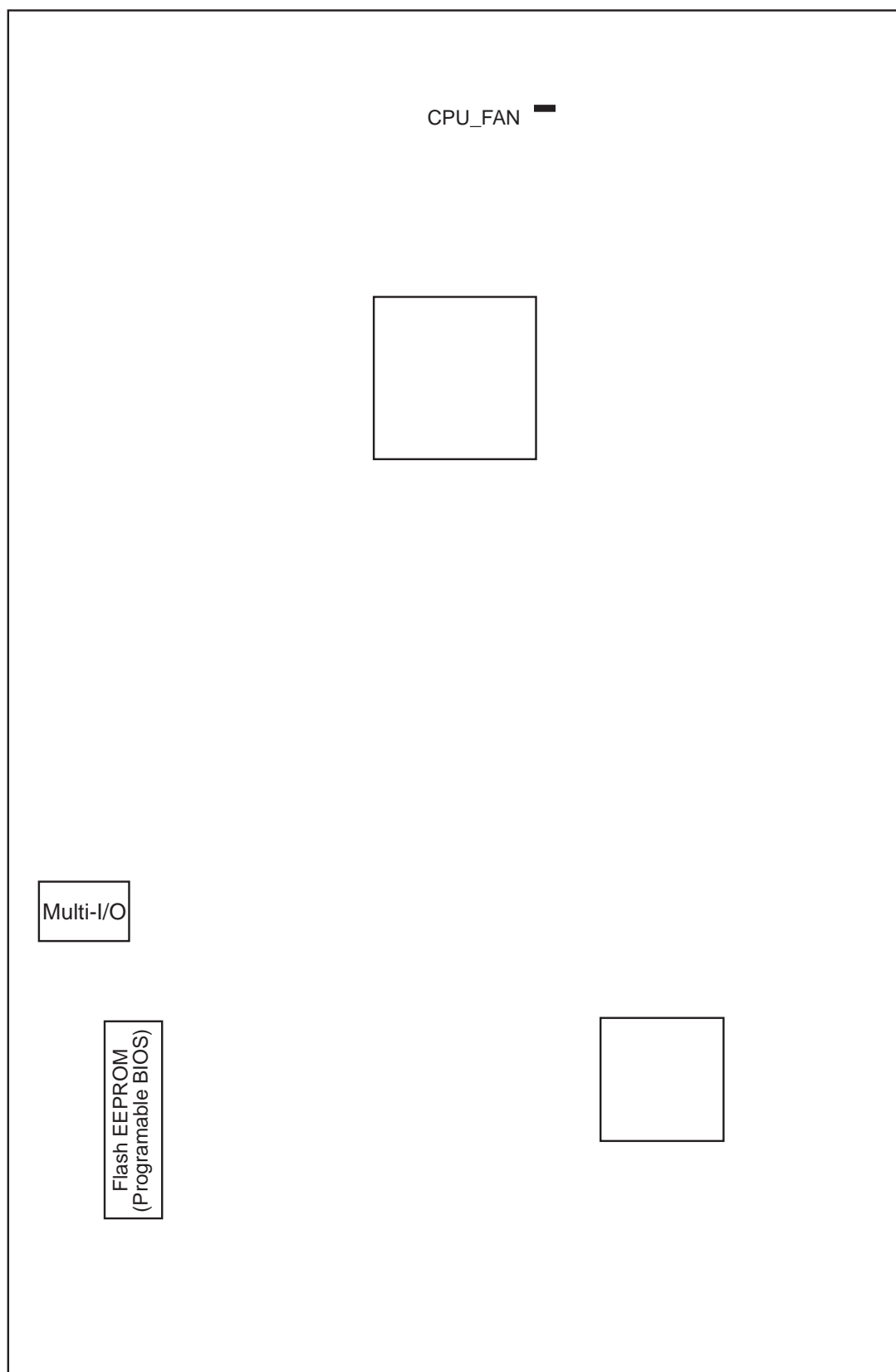

# 3. HARDWARE SETUP

## 3.2 Layout Contents

### Motherboard Settings

- |                      |  |
|----------------------|--|
| 1) DSW-Switch 6      | p. 17 AGP Bus Frequency Setting                    |
| 2) DSW-Switches 7-10 | p. 18 CPU External Clock (BUS) Frequency Selection |
| 3) DSW-Switches 1-4  | p. 19 CPU Core:BUS Frequency Multiple              |
| 4) JEN               | p. 20 JumperFree™ Mode Setting (Enable/Disable)    |
| 5) JP20              | p. 20 I/O Voltage Setting (3.50/3.65 Volt)         |

### Expansion Slots/Sockets

- |                   |  |
|-------------------|--|
| 1) System Memory  | p. 21 System Memory Support                          |
| 2) DIMM0,1,2,3    | p. 22 DIMM Memory Module Support                     |
| 3) Slot 1         | p. 23 CPU Support                                    |
| 4) SLOT1, SLOT2   | p. 28 16-bit ISA Bus Expansion Slots (optional)      |
| 5) PCI1,2,3,4,5,6 | p. 28 32-bit PCI Bus Expansion Slots (optional PCI6) |
| 6) AGP            | p. 29 Accelerated Graphics Port                      |

### Connectors

- |                          |   |
|--------------------------|---|
| 1) PS2KBMS               | p. 30 PS/2 Mouse Port Connector (6 pin-female)                      |
| 2) PS2KBMS               | p. 30 PS/2 Keyboard Port Connector (6-pin female)                   |
| 3) PARALLEL              | p. 31 Parallel (Printer) Port Connector (25-pin female)             |
| 4) COM1, COM2            | p. 31 Serial Port COM1 & COM2 (two 9-pin male)                      |
| 5) FLOPPY                | p. 31 Floppy Drive Port Connector (34 pins)                         |
| 6) USB                   | p. 32 Universal Serial Bus Port Connectors 1 & 2 (Two 4-pin female) |
| 7) Primary/Secondary IDE | p. 32 Primary/Secondary IDE Connectors (Two 40-1 pins)              |
| 8) IDELED                | p. 33 IDE Device Activity LED (2 pins)                              |
| 9) CHA_, PWR_, CPU_FAN   | p. 33 Chassis, Power Supply, CPU Fan Power Connectors (3 pins)      |
| 10) IR                   | p. 34 IrDA-Compliant Infrared Module Connector (5 pins)             |
| 11) SMB                  | p. 34 SMBus Connector (3 pins)                                      |
| 12) WOL_CON              | p. 35 Wake-On-LAN Connector (3 pins)                                |
| 13) WOR                  | p. 35 Wake-On-Ring Connector (2 pins)                               |
| 14) CHASSIS              | p. 36 Chassis Intrusion Alarm Lead (3 pins)                         |
| 15) PWR.LED (PANEL)      | p. 36 System Power LED Lead (3 pins)                                |
| 16) KEYLOCK (PANEL)      | p. 36 Keyboard Lock Switch Lead (2 pins)                            |
| 17) SPEAKER (PANEL)      | p. 36 System Warning Speaker Connector (4 pins)                     |
| 18) MSG.LED (PANEL)      | p. 36 System Message LED Lead (2 pins)                              |
| 19) SMI (PANEL)          | p. 36 System Management Interrupt Lead (2 pins)                     |
| 20) PWR.SW (PANEL)       | p. 37 ATX / Soft-Off Switch Lead (2 pins)                           |
| 21) RESET (PANEL)        | p. 37 Reset Switch Lead (2 pins)                                    |
| 22) ATXPWR               | p. 38 ATX Power Supply Connector (20 pins)                          |
| 23) JTPWR                | p. 38 Thermal Sensor Connector                                      |

# 3. HARDWARE SETUP

---

## 3.3 Hardware Setup Procedure

Before using your computer, you must complete the following steps:

1. Check Motherboard Settings
2. Install Memory Modules
3. Install the Central Processing Unit (CPU)
4. Install Expansion Cards
5. Connect Ribbon Cables, Panel Wires, and Power Supply
6. Setup the BIOS Software

## 3.4 Motherboard Settings

This section explains in detail how to change your motherboard's function settings through the use of switches and/or jumpers.

**WARNING!** Computer motherboards and expansion cards contain very delicate Integrated Circuit (IC) chips. To protect them against damage from static electricity, you should follow some precautions whenever you work on your computer.

1. Unplug your computer when working on the inside.
2. Use a grounded wrist strap before handling computer components. If you do not have one, touch both of your hands to a safely grounded object or to a metal object, such as the power supply case.
3. Hold components by the edges and try not to touch the IC chips, leads or connectors, or other components.
4. Place components on a grounded antistatic pad or on the bag that came with the component whenever the components are separated from the system.



# 3. HARDWARE SETUP

## Motherboard Feature Settings (DIP Switches–DSW)

The motherboard's onboard functions are adjusted through the DIP switches. The white block represents the switch's position. The example below shows all the switches in the OFF position.

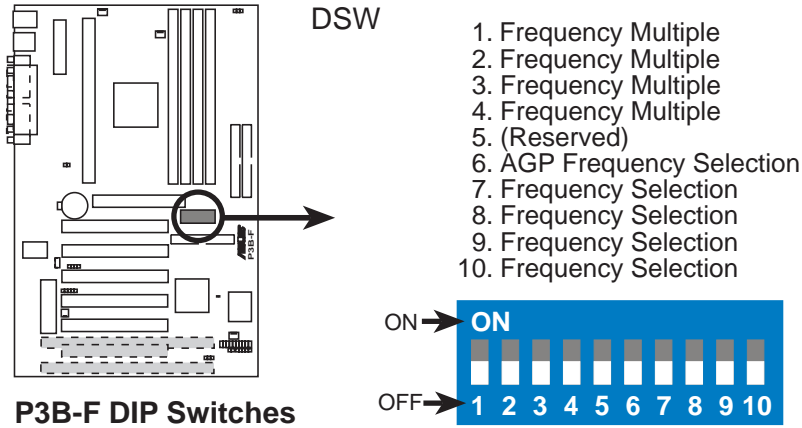

### 1) AGP Bus Frequency Setting (DSW-Switch 6)

This option sets the frequency ratio between the AGP bus frequency and the DRAM (CPU bus) frequency. The default sets the AGP bus frequency to be 2/3 of the DRAM frequency. When the CPU/DRAM frequency is set to 66MHz, set this switch to [ON]. See the processor table on the next page.

<b>Setting</b>	<b>DSW-Switch 6</b>
DRAM Freq. x 2/3	[OFF] (default)
DRAM Freq. x 1	[ON]

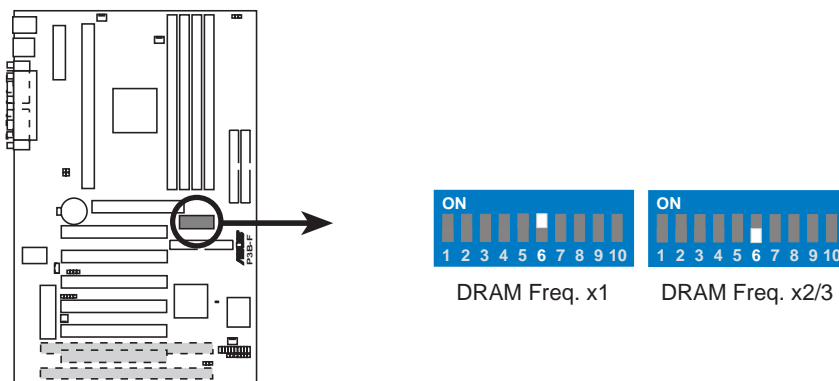

**WARNING!** AGP bus frequencies above 66MHz exceed the specifications for the AGP interface and are not guaranteed to be stable.

# 3. HARDWARE SETUP

## 2) CPU External Frequency Selection (DSW-Switches 7-10)

This option tells the clock generator what frequency to send to the CPU, DRAM, and the PCI bus. This allows the selection of the CPU's *External* frequency (or *BUS Clock*). The BUS Clock multiplied by the Frequency Multiple equals the CPU's *Internal* frequency (the advertised CPU speed).

**NOTE:** In JumperFree mode, all dip switches (DSW) must be set to OFF.

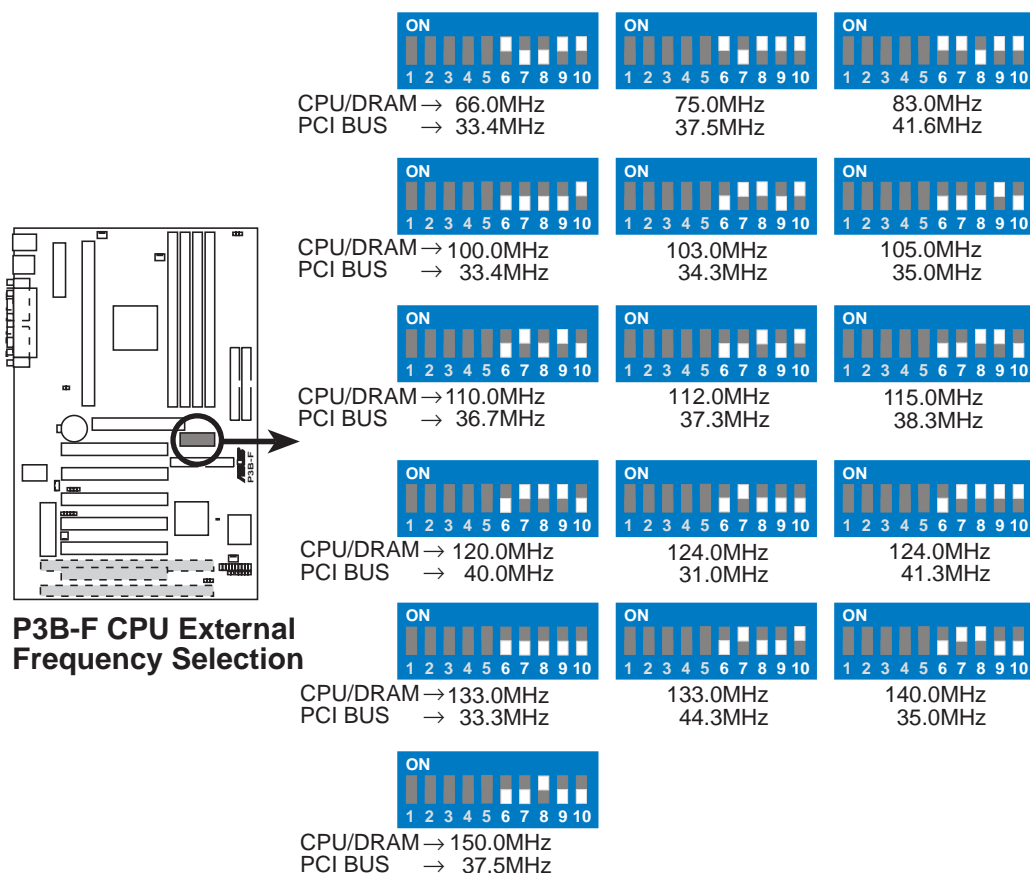

**NOTE:** Overclocking your processor is not recommended. It may result in a slower speed. Voltage Regulator Output Selection (VID) is not needed for the Pentium III / II / Celeron processor because it sends VID signals directly to the onboard power controller.

**WARNING!** Frequencies above 100MHz exceed the specifications for the onboard Intel Chipset and are not guaranteed to be stable.

# 3. HARDWARE SETUP

## 3) CPU Core:BUS Frequency Multiple (DSW-Switches 1-4)

This option sets the frequency multiple between the *Internal* frequency of the CPU and the CPU's *External* frequency. These must be set in conjunction with the *CPU Bus Frequency*.

**NOTE:** In JumperFree™ mode, all dip switches (DSW) must be set to OFF.

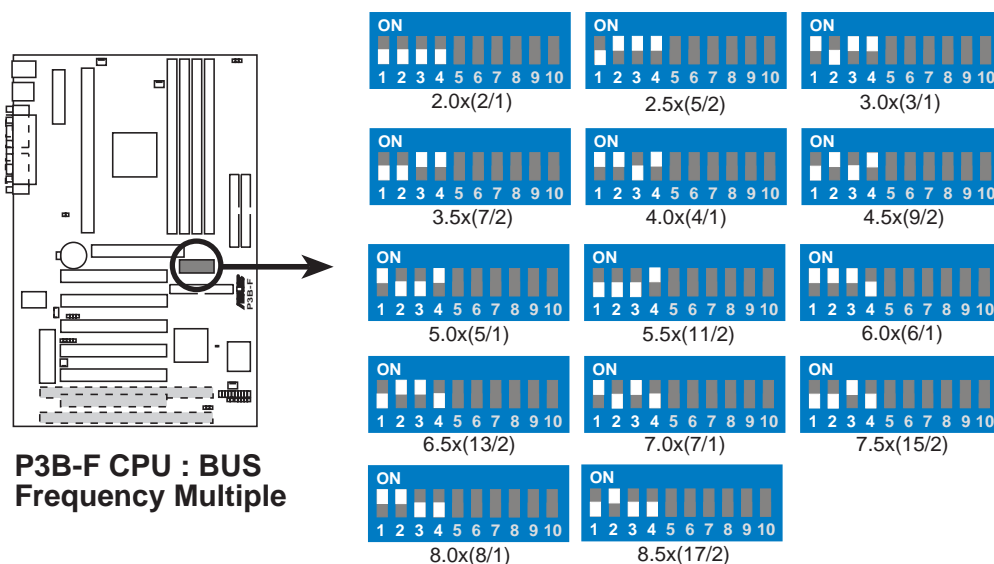

### Manual CPU Settings

**NOTE:** JumperFree mode must be disabled .

*Set the DIP switches by the Internal speed of your processor as follows:*

Intel CPU Model	Freq.	Mult.	Bus F.	(CPU BUS Freq.)				(Freq. Multiple)				(AGP)
				7	8	9	10	1	2	3	4	
Pentium III	600MHz	6.0x	100MHz	[OFF]	[OFF]	[OFF]	[ON]	[ON]	[ON]	[OFF]	[OFF]	[OFF]
Pentium III	550MHz	5.5x	100MHz	[OFF]	[OFF]	[OFF]	[ON]	[OFF]	[OFF]	[OFF]	[ON]	[OFF]
Pentium III	500MHz	5.0x	100MHz	[OFF]	[OFF]	[OFF]	[ON]	[ON]	[OFF]	[OFF]	[ON]	[OFF]
Pentium III/II	450MHz	4.5x	100MHz	[OFF]	[OFF]	[OFF]	[ON]	[OFF]	[ON]	[OFF]	[ON]	[OFF]
Pentium II	400MHz	4.0x	100MHz	[OFF]	[OFF]	[OFF]	[ON]	[ON]	[ON]	[OFF]	[ON]	[OFF]
Pentium II	350MHz	3.5x	100MHz	[OFF]	[OFF]	[OFF]	[ON]	[OFF]	[OFF]	[ON]	[ON]	[OFF]
Celeron	500MHz	7.5x	66MHz	[OFF]	[OFF]	[ON]	[ON]	[OFF]	[OFF]	[ON]	[OFF]	[ON]
Celeron	466MHz	7.0x	66MHz	[OFF]	[OFF]	[ON]	[ON]	[ON]	[OFF]	[ON]	[OFF]	[ON]
Celeron	433MHz	6.5x	66MHz	[OFF]	[OFF]	[ON]	[ON]	[OFF]	[ON]	[ON]	[OFF]	[ON]
Celeron	400MHz	6.0x	66MHz	[OFF]	[OFF]	[ON]	[ON]	[ON]	[ON]	[ON]	[OFF]	[ON]
Celeron	366MHz	5.5x	66MHz	[OFF]	[OFF]	[ON]	[ON]	[OFF]	[OFF]	[OFF]	[ON]	[ON]
Pentium II/Celeron	333MHz	5.0x	66MHz	[OFF]	[OFF]	[ON]	[ON]	[ON]	[OFF]	[OFF]	[ON]	[ON]
Pentium II/Celeron	300MHz	4.5x	66MHz	[OFF]	[OFF]	[ON]	[ON]	[OFF]	[ON]	[OFF]	[ON]	[ON]
Pentium II/Celeron	266MHz	4.0x	66MHz	[OFF]	[OFF]	[ON]	[ON]	[ON]	[ON]	[OFF]	[ON]	[ON]
Pentium II	233MHz	3.5x	66MHz	[OFF]	[OFF]	[ON]	[ON]	[OFF]	[OFF]	[ON]	[ON]	[ON]

For updated processor settings, please visit ASUS' web site (see ASUS CONTACT INFORMATION).

# 3. HARDWARE SETUP

## 4) JumperFree™ Mode Setting (JEN)

This allows you to enable or disable JumperFree™ mode. JumperFree™ mode allows processor settings to be made through BIOS setup (see *4.4 Advanced Menu*).

**NOTE:** In JumperFree™ mode, all dip switches (DSW) must be set to OFF.

<b>Setting</b>	<b>JEN</b>
Enable (jumperfree)	[2-3] (default)
Disable (jumper)	[1-2]

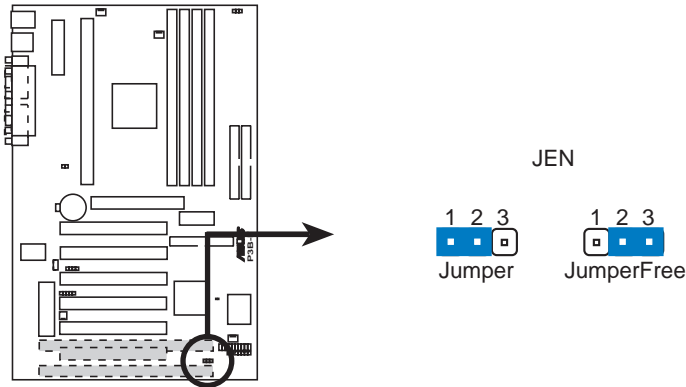

**P3B-F Jumper Mode Setting**

## 5) I/O Voltage Setting (JP20)

This jumper allows you to select the voltage supplied to the DRAM, chipset, and AGP.

<b>Setting</b>	<b>JP20</b>
3.50 Volt	[1-2] (default)
3.65 Volt	[2-3]

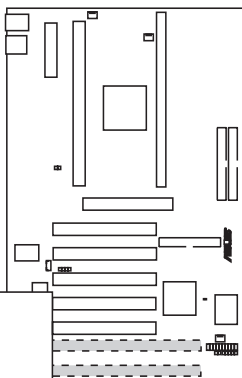

# 3. HARDWARE SETUP

## 3.5 System Memory (DIMM)

**NOTE:** No hardware or BIOS setup is required after adding or removing memory. This motherboard uses only Dual Inline Memory Modules (DIMMs). Sockets are available for **3.3Volt** (power level) unbuffered Synchronous Dynamic Random Access Memory (SDRAM). One side (with memory chips) of the DIMM takes up one row on the motherboard.

To utilize the chipset's Error Checking and Correction (ECC) feature, you must use a DIMM module with 9 chips per side (standard 8 chips/side + 1 ECC chip) and make the proper settings through **4.4.1 Chip Configuration**.

Memory speed setup is recommended through **SDRAM Configuration** in **4.4.1 Chip Configuration**.

*Install memory in any combination as follows:*

DIMM Location	168-pin DIMM		Total Memory
Socket 1 (Rows 0&1)	SDRAM 8, 16, 32, 64, 128, 256MB	x1	
Socket 2 (Rows 2&3)	SDRAM 8, 16, 32, 64, 128, 256MB	x1	
Socket 3 (Rows 4&5)	SDRAM 8, 16, 32, 64, 128, 256MB	x1	
Socket 4 (Rows 6&7)	SDRAM 8, 16, 32, 64, 128, 256MB	x1	
	<b>Total System Memory (Max 1024MB)</b>	=	

**NOTE:** At the time this User's Manual was written, 256MB DIMMs are only available as double-sided registered memory.

### 3.5.1 General DIMM Notes

- **For the system CPU bus to operate at 100MHz, use only PC100-compliant DIMMs.** When this motherboard operates at 100MHz, most system will not even boot if non-compliant modules are used because of the strict timing issues involved under this speed. If your DIMMs are not PC100-compliant, set the CPU bus frequency to 66MHz RAM to ensure system stability.
- ASUS motherboards support SPD (Serial Presence Detect) DIMMs. This is the memory of choice for best performance vs. stability.
- Two possible memory chips are supported: SDRAM with and without ECC.
- SDRAM chips are generally thinner with higher pin density than EDO (Extended Data Output) chips.
- BIOS shows SDRAM memory on bootup screen.
- Single-sided DIMMs come in 16, 32, 64,128MB; double-sided come in 32, 64, 128, 256MB.

# 3. HARDWARE SETUP

## 3.5.2 DIMM Memory Installation

Insert the module(s) as shown. Because the number of pins are different on either side of the breaks, the module will only fit in the orientation shown. DRAM SIMM modules have the same pin contacts on both sides. SDRAM DIMMs have different pin contacts on each side and therefore have a higher pin density.

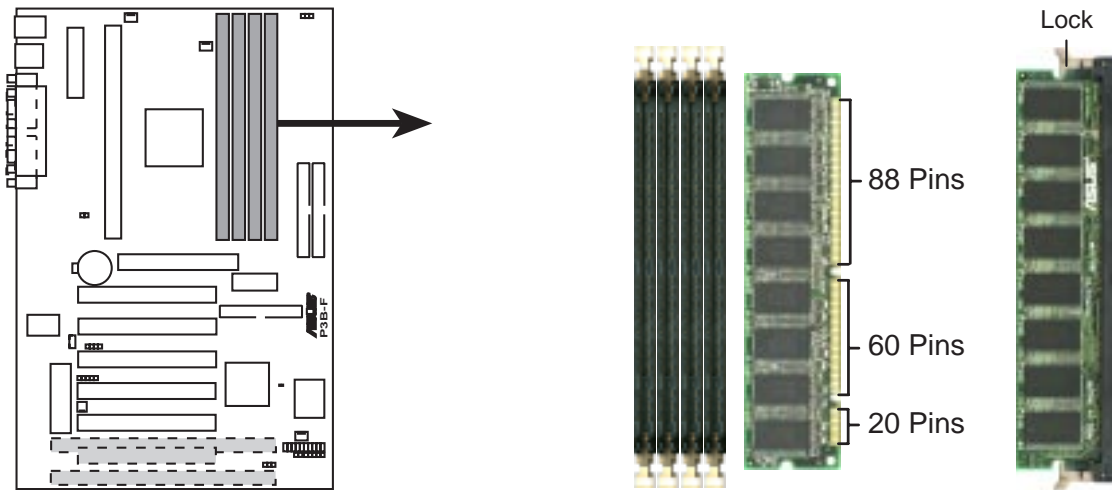

### P3B-F 168-Pin DIMM Memory Sockets

The DIMMs must be 3.3Volt unbuffered SDRAMs. To determine the DIMM type, check the notches on the DIMMs (see figure below).

#### 168-Pin DIMM Notch Key Definitions (3.3V)

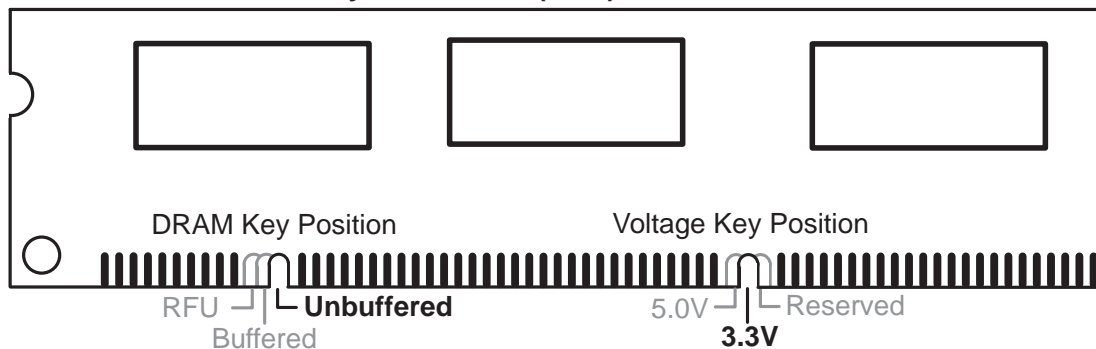

The notches on the DIMM will shift between left, center, or right to identify the type and also to prevent the wrong type from being inserted into the DIMM slot on the motherboard. You must tell your retailer the correct DIMM type before purchasing. This motherboard supports four clock signals per DIMM.

## 3. HARDWARE SETUP

---

### 3.6 Central Processing Unit (CPU)

**NOTE:** The following pictures are provided for reference purposes only. The appearance of your retention mechanism and fan may be different from the following examples.

Your motherboard provides a Slot 1 connector for a Pentium® III processor packaged in a Single Edge Contact Cartridge (SECC2), a Pentium® II processor packaged in SECC2/SECC, or a Celeron™ processor packaged in a Single Edge Processor Package (SEPP). An ASUS S370 CPU card can allow Socket 370 processors to be used on any ASUS motherboard with the Slot 1 connector (See **7.2 S370 Series CPU Transform Card** for instructions on using this card).

#### 3.6.1 Universal Retention Mechanism

Your motherboard comes preinstalled with a Universal Retention Mechanism (URM). The URM supports Pentium III / II and Celeron processors.



# 3. HARDWARE SETUP

---

## 3.6.3 Installing the Processor

To unlock the support arms, simply flip them up to an upright position.

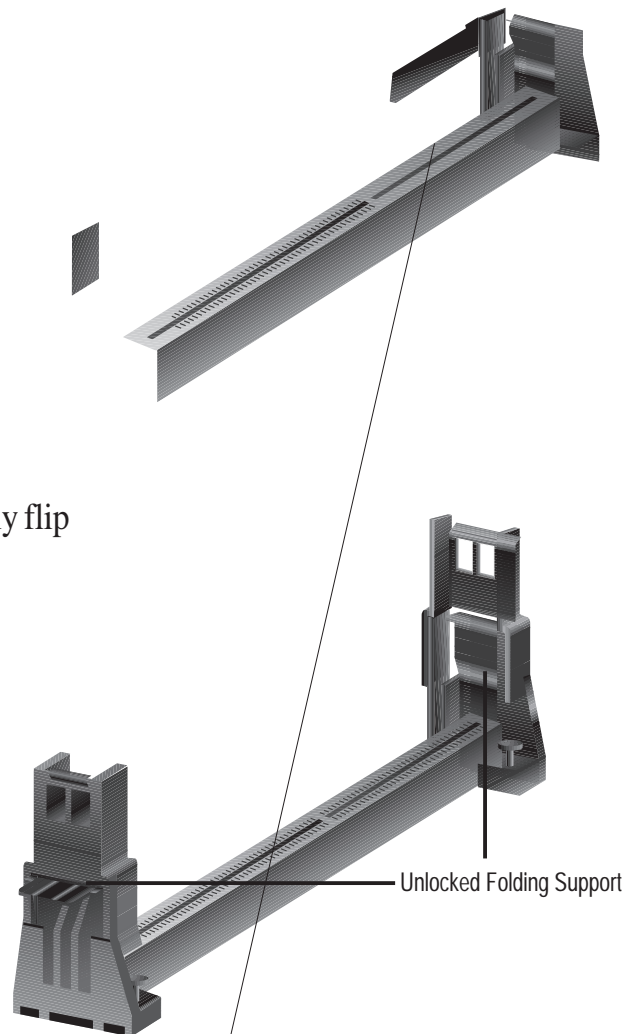

The URM is now ready for the installation of your processor.



# 3. HARDWARE SETUP

## 2. Attach the Heatsink

**NOTE:** If provided, you should follow the heatsink attachment instructions that came with your heatsink or processor. The following steps are provided only as a general guide and may not reflect those for your heatsink.

### Using the SECC fan with the Pentium® II

Push the two lock arms one direction to clamp the heatsink onto the processor and the other direction to release.

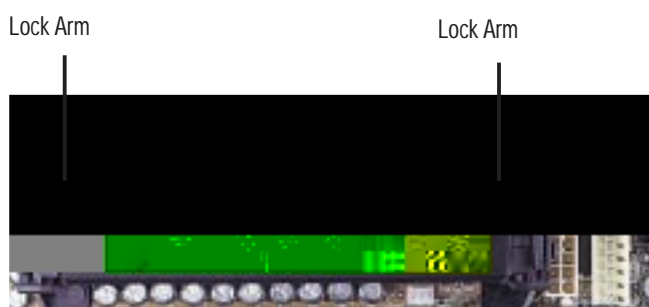

### Using the SECC2 fan with the Pentium® III

Insert the four heatsink's pins through the holes of the SECC2. Place the metal clip on the ends of the pins and slide until it locks into place.

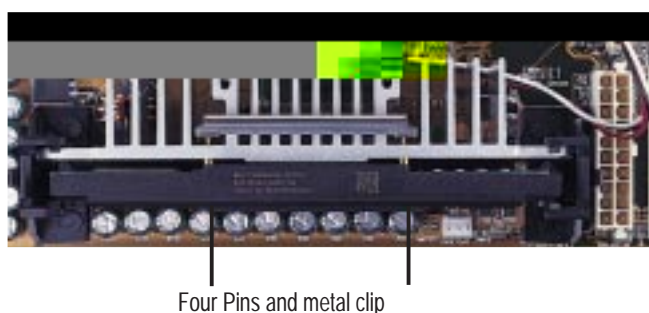

**NOTE:** The SEPP heatsink and fan (for Intel Celeron processors) is similar to the SECC2 heatsink and fan except that the clamping design is different.

**WARNING!** Make sure the heatsink is mounted tightly against the SECC2, SECC, or SEPP; otherwise, the CPU will overheat. You may install an auxiliary fan to provide adequate circulation across the processor's passive heatsink.



## 3. HARDWARE SETUP

---

### 3.6.4 Recommended Heatsinks for Slot 1 Processors

The recommended heatsinks for the Slot 1 processors are those with three-pin fans, such as the ASUS Smart Fan, that can be connected to the motherboard's CPU fan connector. These heatsinks dissipate heat more efficiently and with an optional hardware monitor, they can monitor the fan's RPM and use the alert function with the Intel LANDesk Client Manager (LDCM) or the ASUS PC Probe software.



**SECC Heatsink & Fan**



**SECC2 Heatsink & Fan**

**NOTE:** The SEPP heatsink and fan (for Intel Celeron processors) is similar to the SECC2 heatsink and fan except that the clamping design is different.

# 3. HARDWARE SETUP

## 3.7 Expansion Cards

**WARNING!** Unplug your power supply when adding or removing expansion cards or other system components. Failure to do so may cause severe damage to both your motherboard and expansion cards.

### 3.7.1 Expansion Card Installation Procedure

1. Read the documentation for your expansion card and make any necessary hardware or software settings for your expansion card, such as jumpers.
2. Remove your computer system's cover and the bracket plate on the slot you intend to use. Keep the bracket for possible future use.
3. Carefully align the card's connectors and press firmly.
4. Secure the card on the slot with the screw you removed above.
5. Replace the computer system's cover.
6. Set up the BIOS if necessary  
(such as *IRQ xx Used By ISA: Yes* in PNP AND PCI SETUP)
7. Install the necessary software drivers for your expansion card.

### 3.7.2 Assigning IRQs for Expansion Cards

Some expansion cards need to use an IRQ to operate. Generally, an IRQ must be exclusively assigned to one use. In a standard design, there are 16 IRQs available but most of them are already in use, leaving 6 IRQs free for expansion cards. If your motherboard has **PCI** audio onboard, an extra IRQ will be used, leaving 5 IRQs free. If your motherboard has **ISA** audio onboard, an extra 3 IRQs will be used, leaving 3 IRQs free.

Both ISA and PCI expansion cards may require to use IRQs. System IRQs are available to cards installed in the ISA expansion bus first, then any remaining IRQs are available to PCI cards. Currently, there are two types of ISA cards. The original ISA expansion card design, now referred to as legacy ISA cards, requires that you configure the card's jumpers manually and then install it in any available slot on the ISA bus. To see a map of your used and free IRQs in Windows 98, the **Control Panel** icon in **My Computer**, contains a **System** icon, which gives you a **Device Manager** tab. Double-clicking on a specific hardware device gives you the Resources tab which shows the Interrupt number and address. Make sure that no two devices use the same IRQ or your computer will experience problems when those two devices are in use at the same time.

## 3. HARDWARE SETUP

To simplify this process, this motherboard complies with the Plug and Play (PnP) specification which was developed to allow automatic system configuration whenever a PnP-compliant card is added to the system. For PnP cards, IRQs are assigned automatically from those available.

If the system has both Legacy and PnP ISA cards installed, IRQs are assigned to PnP cards from those not used by Legacy cards. The PCI and PnP configuration of the BIOS setup utility can be used to indicate which IRQs are being used by Legacy cards. For older Legacy cards that do not work with the BIOS, you can contact your vendor for an ISA Configuration Utility.

An IRQ number is automatically assigned to PCI expansion cards after those used by Legacy and PnP ISA cards. In the PCI bus design, the BIOS automatically assigns an IRQ to PCI cards that require an IRQ. To install a PCI card, you need to set something called the INT (interrupt) assignment. Since all the PCI slots on this motherboard use an INTA #, be sure that the jumpers on your PCI cards are set to INT A.

### 3.7.3 Assigning DMA Channels for ISA Cards

Some ISA cards, both legacy and PnP, may also need to use a DMA (Direct Memory Access) channel. DMA assignments for this motherboard are handled the same way as the IRQ assignment process described earlier. You can select a DMA channel in the PCI and PnP configuration section of the BIOS Setup utility.

**IMPORTANT:** To avoid conflicts, reserve the necessary IRQs and DMAs for legacy ISA cards (see **PCI/PNP ISA IRQ/DMA Resource Exclusion** in **4.4.3 PCI Configuration**. Choose *Yes* in *IRQ xx Used By ISA* and *DMA x Used By ISA* for those IRQs and DMAs you want to reserve).

### 3.7.4 Accelerated Graphics Port (AGP)

This motherboard provides an accelerated graphics port (AGP) slot to support a new generation of graphics cards with ultra-high memory bandwidth, such as an ASUS 3D Hardware Accelerator.

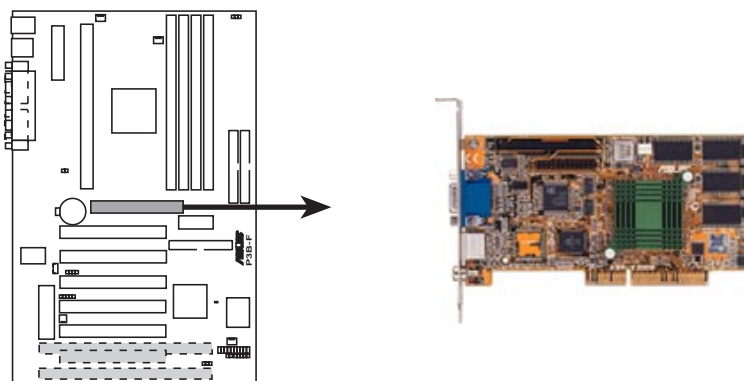

**P3B-F Accelerated Graphics Port (AGP)**

---

## 3.8 External Connectors

**IMPORTANT:** Ribbon cables should always be connected with the red stripe to Pin 1 on the connectors. Pin 1 is usually on the side closest to the power connector on hard drives and CD-ROM drives, but may be on the opposite side on floppy disk drives. Check the connectors before installation because there may be exceptions. IDE ribbon cables must be less than 46 cm (18 in.), with the second drive connector no more than 15 cm (6 in.) from the first connector.

### 1) PS/2 Mouse Connector (6-pin PS2KBMS)

The system will direct IRQ12 to the PS/2 mouse if one is detected. If not detected, expansion cards can use IRQ12. See **PS/2 Mouse Function Control** in *4.4 Advanced Menu*.

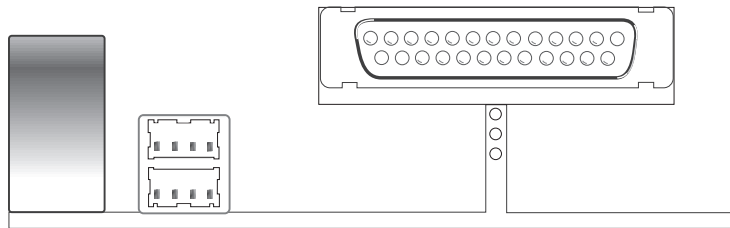

# 3. HARDWARE SETUP

## 3) Parallel Port Connector (25-pin PARALLEL)

You can enable the parallel port and choose the IRQ through **Onboard Parallel Port** in *4.2.2 I/O Device Configuration*. **NOTE:** Serial printers must be connected to the serial port.

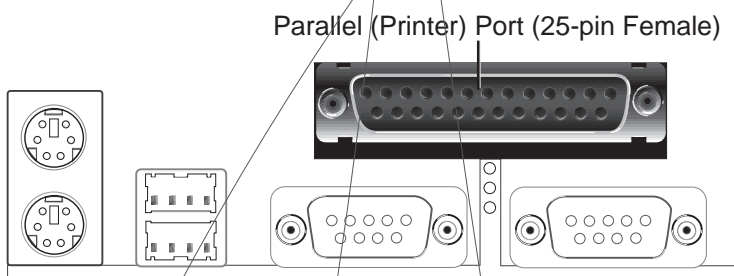

## 4) Serial Port Connectors (9-pin COM1/COM2)

The two serial ports can be used for pointing devices or other serial devices. See **Onboard Serial Port** in *4.2.2 I/O Device Configuration*.

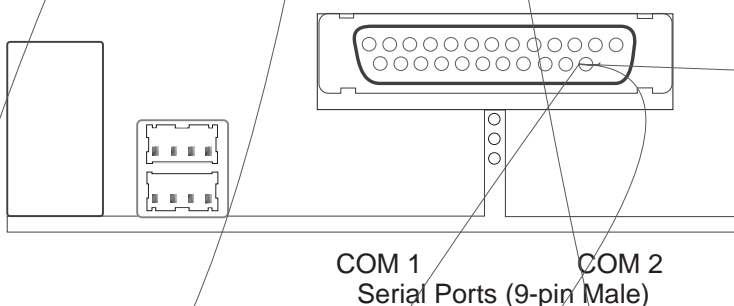





# 3. HARDWARE SETUP

## 8) IDE Device Activity LED (2-pin IDELED)

This connector supplies power to the cabinet's IDE device activity LED. Read and write activity by devices connected to the Primary or Secondary IDE connectors will cause the LED to light up.

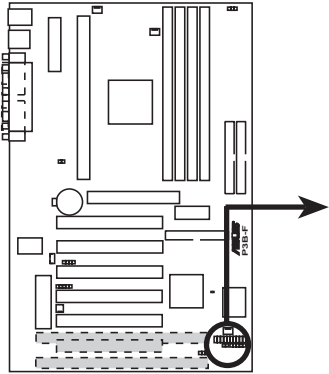

**TIP:** If the case-mounted LED does not light, try reversing the 2-pin plug.

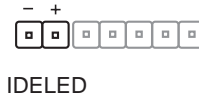

**P3B-F IDE Activity LED**

## 9) Chassis, Power Supply, CPU Fan Connectors (3-pin CHA\_,PWR\_,CPU\_FAN)

These connectors support cooling fans of 500mA (6W) or less. Orientate the fans so that the heat sink fins allow airflow to go across the onboard heat sink(s) instead of the expansion slots. Depending on the fan manufacturer, the wiring and plug may be different. The red wire should be positive, while the black should be ground. Connect the fan's plug to the board taking into consideration the polarity of the connector. **NOTE:** The "Rotation" signal is to be used only by a specially designed fan with rotation signal. The Rotations per Minute (RPM) can be monitored using ASUS PC Probe Utility or Intel LDCM Utility (see **6. Software Reference**).

**WARNING!** The CPU and/or motherboard will overheat if there is no airflow across the CPU and onboard heatsinks. Damage may occur to the motherboard and/or the CPU fan if these pins are incorrectly used. **These are not jumpers, do not place jumper caps over these pins.**

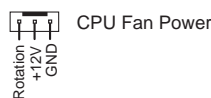
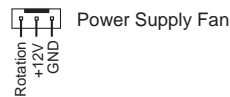
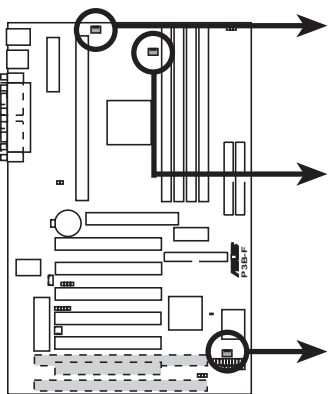

**P3B-F 12Volt Cooling Fan Power**

# 3. HARDWARE SETUP

## 10) IrDA-Compliant Infrared Module Connector (5-pin IR)

This connector supports the optional wireless transmitting and receiving infrared module. This module mounts to a small opening on system cases that support this feature. You must also configure the setting through **UART2 Use Infrared** in **4.4.2 I/O Device Configuration** to select whether UART2 is directed for use with COM2 or IrDA. Use the five pins as shown on the Back View and connect a ribbon cable from the module to the motherboard according to the pin definitions.

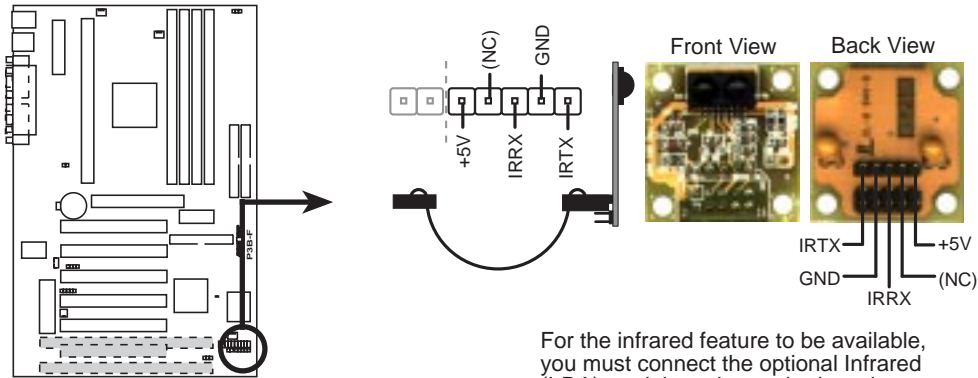

**P3B-F Infrared Module Connector**

## 11) SMBus Connector (5-1 pin SMB)

This connector allows you to connect SMBus devices. SMBus devices communicate by means of the SMBus with an SMBus host and/or other SMBus devices. The SMBus or System Management Bus is a specific implementation of an I<sup>2</sup>C bus, which is a multi-master bus, that is, multiple chips can be connected to the same bus and each one can act as a master by initiating data transfer.

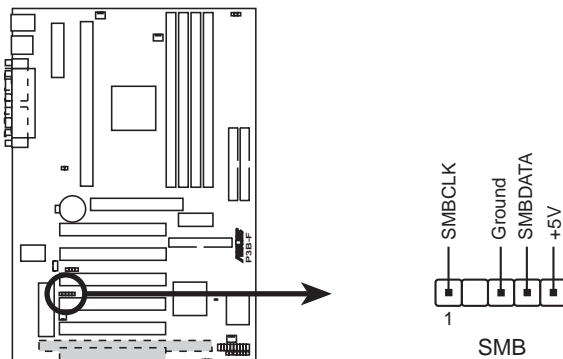

**P3B-F SMBus Connector**

# 3. HARDWARE SETUP

## 12) Wake-On-LAN Connector (3-pin WOL\_CON)

The WOL\_CON connector powers up the system when a wake-up packet or signal is received from the network through the ASUS PCI-L101 LAN card.

**IMPORTANT:** This feature requires that **Wake-On-LAN** is set to *Enabled* (see *4.5.1 Power Up Control*) and that your system has an ATX power supply with at least 720mA +5V standby power.

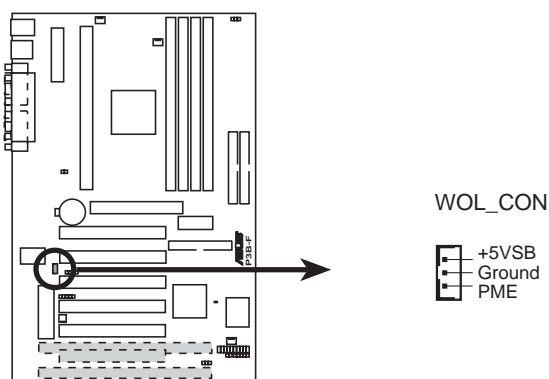

**P3B-F Wake-On-LAN Connector**

## 13) Wake-On-Ring Connector (2-pin WOR)

This connector connects to an internal modem card with a Wake-On-Ring output. The connector powers up the system when a ringup packet or signal is received through the internal modem card. **NOTE:** For external modems, Wake-On-Ring is detected through the COM port.

**IMPORTANT:** This feature requires that **PWR Up On Modem Act** is set to *Enabled* (see *4.5.1 Power Up Control*).

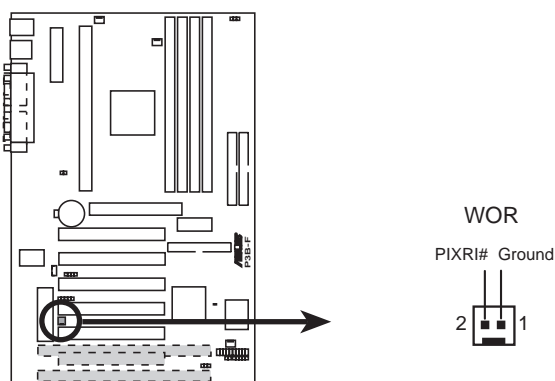

**P3B-F Wake-On-Ring Connector**

# 3. HARDWARE SETUP

## 14) Chassis Intrusion Alarm Lead (4-1 pin CHASSIS)

This requires an external detection mechanism such as a chassis intrusion monitor/sensor or microswitch. The sensor is triggered when a high level signal is sent to the Chassis Signal lead, which occurs when a panel switch or light detector is triggered.

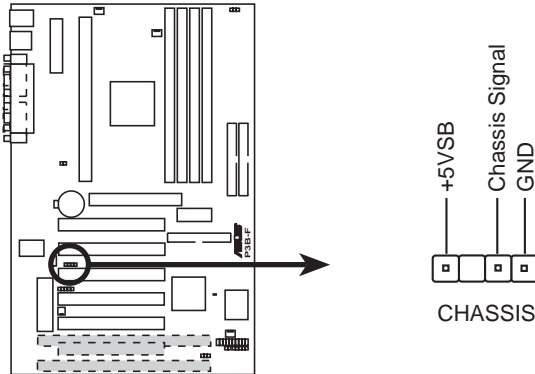

**P3B-F Chassis Intrusion Alarm Lead**

## 15) System Power LED Lead (3-1 pin PWR.LED)

This 3-1 pin connector connects to the system power LED, which lights when the system is powered on, blinks when it is in sleep mode, and turns off when it is in soft-off mode.

## 16) Keyboard Lock Switch Lead (2-pin KEYLOCK)

This 2-pin connector connects to the case-mounted key switch to allow keyboard locking. **NOTE:** When the keyboard is locked, the mouse can still be used.

## 17) System Warning Speaker Connector (4-pin SPEAKER)

This 4-pin connector connects to the case-mounted speaker.

## 18) System Message LED Lead (2-pin MSG.LED)

This indicates whether a message has been received from a fax/modem. The LED will remain lit when there is no signal and blink when there is data received. This function requires an ACPI OS as well as application and driver support.

## 19) System Management Interrupt Lead (2-pin SMI)

This allows the user to manually place the system into a suspend mode or “Green” mode where system activity will be instantly decreased to save electricity and expand the life of certain components when the system is not in use. This 2-pin connector (see the preceding figure) connects to the case-mounted suspend switch. If you do not have a switch for the connector, you may use the “Turbo Switch” since it does not have a function. SMI is activated when it detects a *short to open* moment and therefore leaving it shorted will not cause any problems. This may require one or two pushes depending on the position of the switch.

# 3. HARDWARE SETUP

## 20) ATX Power / Soft-Off Switch Lead (2-pin PWR.SW)

The system power is controlled by a momentary switch connected to this lead. Pushing the button once will switch the system between ON and SLEEP or ON and SOFT OFF, depending on your BIOS or OS setting. Pushing the switch while in the ON mode for more than 4 seconds will turn the system off. The system power LED shows the status of the system's power.

## 21) Reset Switch Lead (2-pin RESET)

This 2-pin connector connects to the case-mounted reset switch for rebooting your computer without having to turn off your power switch. This is a preferred method of rebooting to prolong the life of the system's power supply.

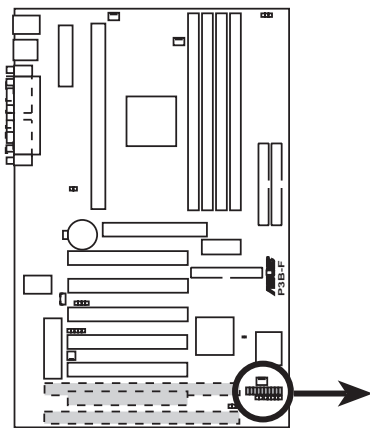

**P3B-F System Panel Connections**

\* Requires an ATX power supply.

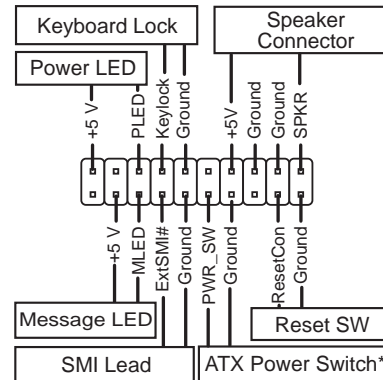

# 3. HARDWARE SETUP

## 22) ATX Power Supply Connector (20-pin ATXPWR)

This connector connects to an ATX power supply. The plug from the power supply will only insert in one orientation because of the different hole sizes. Find the proper orientation and push down firmly but gently making sure that the pins are aligned.

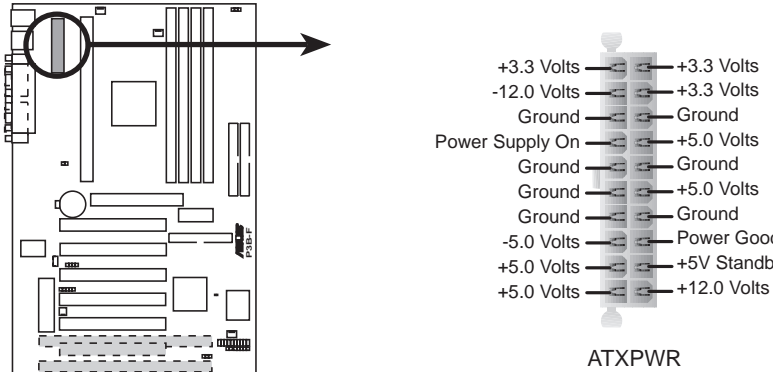

**P3B-F ATX Power Connector**

**IMPORTANT:** Make sure that your ATX power supply can supply at least 10mA on the 5-volt standby lead (5VSB). You may experience difficulty in powering on your system if your power supply cannot support the load. For Wake-On-LAN, keyboard wake up, and suspend-to-RAM support, your ATX power supply must supply at least 720mA +5VSB.

## 23) Power Supply Thermal Sensor Connector

If you have a power supply with thermal monitoring, connect its thermal sensor cable to this connector.

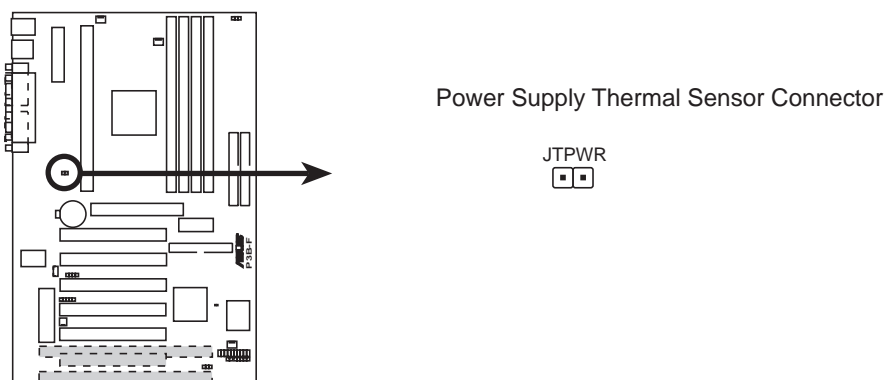

**P3B-F Thermal Sensor Connector**

## 3. HARDWARE SETUP

---

### 3.9 Power Connection Procedures

1. After all connections are made, close the system case cover.
2. Be sure that all switches are off (in some systems, marked with ○).
3. Connect the power supply cord to the power supply located on the back of your system case according to your system user's manual.
4. Connect the power cord to a power outlet that is equipped with a surge protector.
5. You may then turn on your devices in the following order:
  - a. Your monitor
  - b. External SCSI devices (starting with the last device on the chain)
  - c. Your system power

For ATX power supplies, you need to switch ON the power supply if a switch is provided as well as press the ATX power switch on the front of the case.

6. The power LED on the front panel of the system case will light. For ATX power supplies, the system LED will light when the ATX power switch is pressed. The LED on the monitor may light up or switch between orange and green after the system's if it complies with "green" standards or if it has a power standby feature. The system will then run power-on tests. While the tests are running, additional messages will appear on the screen. If you do not see anything within 30 seconds from the time you turn on the power, the system may have failed a power-on test. Check your jumper settings and connections again or call your retailer for assistance.
  7. During power-on, hold down <Delete> to enter BIOS setup. Follow the instructions in **4. BIOS SETUP**.
- \* **Powering Off your computer:** You must first exit or shut down your operating system before switching off the power switch. For ATX power supplies, you can press the ATX power switch after exiting or shutting down your operating system. If you use Windows 95/98, click the **Start** button, click **Shut Down**, and then click **Shut down the computer?**. The power supply should turn off after Windows shuts down.

**NOTE:** The message "You can now safely turn off your computer" will not appear when shutting down with ATX power supplies.

# 4. BIOS SETUP

## 4.1 Managing and Updating Your BIOS

### 4.1.1 Upon First Use of the Computer System

It is recommended that you save a copy of the original motherboard BIOS along with a Flash Memory Writer utility (AFLASH.EXE) to a bootable floppy disk in case you need to reinstall the BIOS later. **AFLASH.EXE** is a Flash Memory Writer utility that updates the BIOS by uploading a new BIOS file to the programmable flash ROM on the motherboard. This file works only in DOS mode. To determine the BIOS version of your motherboard, check the last four numbers of the code displayed on the upper left-hand corner of your screen during bootup. Larger numbers represent a newer BIOS file.

1. Type **FORMAT A:/S** at the DOS prompt to create a bootable system floppy disk. **DO NOT** copy AUTOEXEC.BAT & CONFIG.SYS to the disk.
2. Type **COPY D:\AFLASH\AFLASH.EXE A:\** (assuming D is your CD-ROM drive) to copy AFLASH.EXE to the just created boot disk.

**NOTE:** AFLASH works only in DOS mode. It will not work with DOS prompt in Windows and will not work with certain memory drivers that may be loaded when you boot from your hard drive. It is recommended that you reboot using a floppy.

3. Reboot your computer from the floppy disk. **NOTE:** BIOS setup must specify “Floppy” as the first item in the boot sequence.
4. In DOS mode, type **A:\AFLASH <Enter>** to run AFLASH.

```
ASUS ACPI BIOS
FLASH MEMORY WRITER V1.00
Copyright (C) 1994-99, ASUS/TEK COMPUTER INC.

Flash Memory: Unknown M280020 or SST-25C020 or Intel 128M280
Current BIOS Version: ASUS 305-XE ACPI BIOS Revision 1005
BIOS Model : 305-XE
BIOS Build Date : 03/25/98

Choose one of the followings:
1. Save Current BIOS To File
2. Update BIOS Including Boot Block and ESCD

Enter choice: 111

Press ESC To Exit
```

**IMPORTANT!** If “unknown” is displayed after **Flash Memory:**, the memory chip is either not programmable or is not supported by the ACPI BIOS and therefore, cannot be programmed by the Flash Memory Writer utility.



## 4. BIOS SETUP

5. Select **1. Save Current BIOS to File** from the Main menu and press <Enter>. The **Save Current BIOS To File** screen appears.

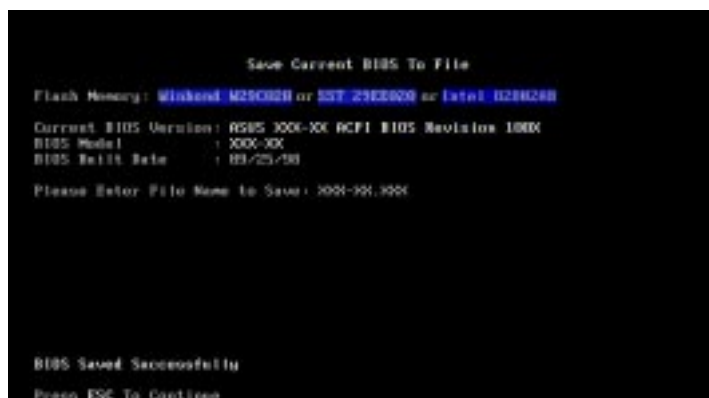

6. Type a filename and the path, for example, **A:\XXX-XX.XXX** and then press <Enter>.

### 4.1.2 Updating BIOS Procedures (only when necessary)

1. Download an updated ASUS BIOS file from the Internet (WWW or FTP) (see ASUS CONTACT INFORMATION on page 3 for details) and save to the disk you created earlier.
2. Boot from the disk you created earlier.
3. At the “A:” prompt, type **AFLASH** and then press <Enter>.
4. At the **Main Menu**, type **2** and then press <Enter>. The **Update BIOS Including Boot Block and ESCD** screen appears.
5. Type the filename of your new BIOS and the path, for example, **A:\XXX-XX.XXX**, and then press <Enter>.

**NOTE:** To cancel this operation, press <Enter>.



## 4. BIOS SETUP

- When prompted to confirm the BIOS update, press **Y** to start the update.

```
Update BIOS Including Boot Block and ESCD
Flash Memory: Winbond W25Q64 or SST 25Q64 or Intel 25Q64
BIOS Version
ECURRNT 3 A515 300-30 ACPI BIOS Revision 1006
Flash.umd3 A515 300-30 ACPI BIOS Revision 1006
BIOS Model
ECURRNT 3 300-30
Flash.umd3 300-30
Date of BIOS Build
ECURRNT 3 09/25/98
E3000.3003 05/23/98
Notice: Boot Block is different. Check size of 1001.B10 is 7200.
Are you sure (Y/N) ? Y

Press ESC to Return to Main Menu
```

- The utility starts to program the new BIOS information into the flash ROM. The boot block will be updated automatically only when necessary. This will minimize the chance of a failed updating. When the programming is finished, *Flashed Successfully* will be displayed.

```
Update BIOS Including Boot Block and ESCD
Flash Memory: Winbond W25Q64 or SST 25Q64 or Intel 25Q64
BIOS Version
ECURRNT 3 A515 300-30 ACPI BIOS Revision 1006
Flash.umd3 A515 300-30 ACPI BIOS Revision 1006
BIOS Model
ECURRNT 3 300-30
Flash.umd3 300-30
Date of BIOS Build
ECURRNT 3 09/25/98
E3000.3003 05/23/98
Notice: Boot Block is different. Check size of 1001.B10 is 7200.
Are you sure (Y/N) ? Y
Block Erasing -- 8888
Programming -- 3FFF
Flashed Successfully
Press ESC to Continue
```

- Follow the onscreen instructions to continue.

**WARNING!** If you encounter problems while updating the new BIOS, DO NOT turn off your system since this might prevent your system from booting up. Just repeat the process, and if the problem still persists, update the original BIOS file you saved to disk above. If the Flash Memory Writer utility was not able to successfully update a complete BIOS file, your system may not be able to boot up. If this happens, your system will need servicing.

# 4. BIOS SETUP

---

## 4.2 BIOS Setup Program

This motherboard supports a programmable EEPROM that can be updated using the provided utility as described in *4.1 Flash Memory Writer Utility*.

The utility is used if you are installing a motherboard, reconfiguring your system, or prompted to “**Run Setup**”. This section describes how to configure your system using this utility.

Even if you are not prompted to use the Setup program, at some time in the future you may want to change the configuration of your computer. For example, you may want to enable the Security Password Feature or make changes to the power management settings. It will then be necessary to reconfigure your system using the BIOS Setup program so that the computer can recognize these changes and record them in the CMOS RAM of the EEPROM.

The EEPROM on the motherboard stores the Setup utility. When you start up the computer, the system provides you with the opportunity to run this program. This appears during the Power-On Self Test (POST). Press <Delete> to call up the Setup utility. If you are a little bit late in pressing the mentioned key, POST will continue with its test routines, thus preventing you from calling up Setup. If you still need to call Setup, restart the system by pressing <Ctrl> + <Alt> + <Delete>, or by pressing the Reset button on the system chassis. You can also restart by turning the system off and then back on again. But do so only if the first two methods fail.

The Setup program has been designed to make it as easy to use as possible. It is a menu-driven program, which means you can scroll through the various sub-menus and make your selections among the predetermined choices.

**To access the BIOS Setup program, press the <Delete> key after the computer has run through its POST.**

**NOTE:** Because the BIOS software is constantly being updated, the following BIOS screens and descriptions are for reference purposes only and may not reflect your BIOS screens exactly.

# 4. BIOS SETUP

## 4.2.1 BIOS Menu Bar

The top of the screen has a menu bar with the following selections:

- MAIN** Use this menu to make changes to the basic system configuration.
- ADVANCED** Use this menu to enable and make changes to the advanced features.
- POWER** Use this menu to configure and enable Power Management features.
- BOOT** Use this menu to configure the default system device used to locate and load the Operating System.
- EXIT** Use this menu to exit the current menu or specify how to exit the Setup program.

To access the menu bar items, press the right or left arrow key on the keyboard until the desired item is highlighted.

## 4.2.2 Legend Bar

At the bottom of the Setup screen you will notice a legend bar. The keys in the legend bar allow you to navigate through the various setup menus. The following table lists the keys found in the legend bar with their corresponding alternates and functions.

Navigation Key(s)	Function Description
<F1> or <Alt + H>	Displays the General Help screen from anywhere in the BIOS Setup
<Esc>	Jumps to the Exit menu or returns to the main menu from a sub-menu
← or → (keypad arrow)	Selects the menu item to the left or right
↑ or ↓ (keypad arrows)	Moves the highlight up or down between fields
- (minus key)	Scrolls backward through the values for the highlighted field
+ (plus key) or spacebar	Scrolls forward through the values for the highlighted field
<Enter>	Brings up a selection menu for the highlighted field
<Home> or <PgUp>	Moves the cursor to the first field
<End> or <PgDn>	Moves the cursor to the last field
<F5>	Resets the current screen to its Setup Defaults
<F10>	Saves changes and exits Setup

# 4. BIOS SETUP

---

## General Help

In addition to the Item Specific Help window, the BIOS setup program also provides a General Help screen. This screen can be called up from any menu by simply pressing <F1> or the <Alt> + <H> combination. The General Help screen lists the legend keys with their corresponding alternates and functions.

## Saving Changes and Exiting the Setup Program

See *4.7 Exit Menu* for detailed information on saving changes and exiting the setup program.

## Scroll Bar

When a scroll bar appears to the right of a help window, it indicates that there is more information to be displayed that will not fit in the window. Use <PgUp> and <PgDn> or the up and down arrow keys to scroll through the entire help document. Press <Home> to display the first page, press <End> to go to the last page. To exit the help window, press <Enter> or <Esc>.

## Sub-Menu



Note that a right pointer symbol (as shown in the left view) appears to the left of certain fields. This pointer indicates that a sub-menu can be launched from this field. A sub-menu contains additional options for a field parameter. To call up a sub-menu, simply move the highlight to the field and press <Enter>. The sub-menu will then immediately appear. Use the legend keys to enter values and move from field to field within a sub-menu just as you would within a menu. Use the <Esc> key to return to the main menu.

Take some time to familiarize yourself with each of the legend keys and their corresponding functions. Practice navigating through the various menus and sub-menus. If you accidentally make unwanted changes to any of the fields, use the set default hot key <F5>. While moving around through the Setup program, note that explanations appear in the Item Specific Help window located to the right of each menu. This window displays the help text for the currently highlighted field.

**NOTE:** The item heading in square brackets represents the default setting for that field.

# 4. BIOS SETUP

## 4.3 Main Menu

When the Setup program is accessed, the following screen appears:

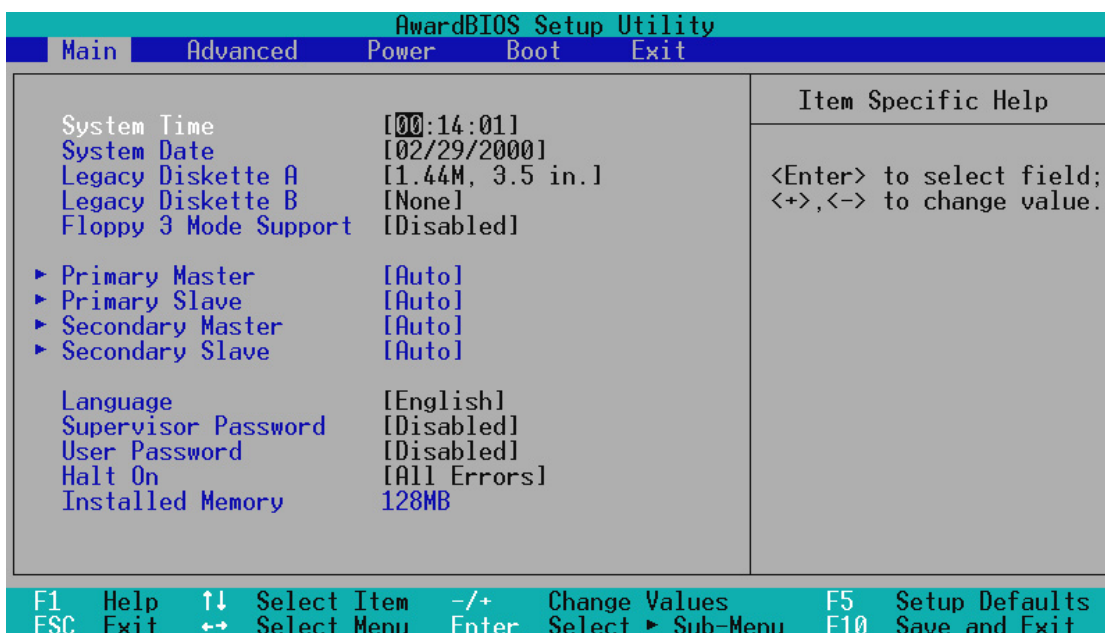

### System Time [XX:XX:XX]

Sets your system to the time that you specify (usually the current time). The format is hour, minute, second. Valid values for hour, minute and second are **Hour: (00 to 23)**, **Minute: (00 to 59)**, **Second: (00 to 59)**. Use the <Tab> or <Shift> + <Tab> keys to move between the hour, minute, and second fields.

### System Date [XX/XX/XXXX]

Sets your system to the date that you specify (usually the current date). The format is month, day, year. Valid values for month, day, and year are **Month: (1 to 12)**, **Day: (1 to 31)**, **Year: (100 year range)**. Use the <Tab> or <Shift> + <Tab> keys to move between the month, day, and year fields.

### Legacy Diskette A [1.44M, 3.5 in.], Legacy Diskette B [None]

Sets the type of floppy drives installed. Configuration options: [None] [360K, 5.25 in.] [1.2M , 5.25 in.] [720K , 3.5 in.] [1.44M, 3.5 in.] [2.88M, 3.5 in.]

### Floppy 3 Mode Support [Disabled]

This is required to support older Japanese floppy drives. Floppy 3 Mode support will allow reading and writing of 1.2MB (as opposed to 1.44MB) on a 3.5-inch diskette. Configuration options: [Disabled] [Drive A] [Drive B] [Both]

# 4. BIOS SETUP

## 4.3.1 Primary & Secondary Master/Slave

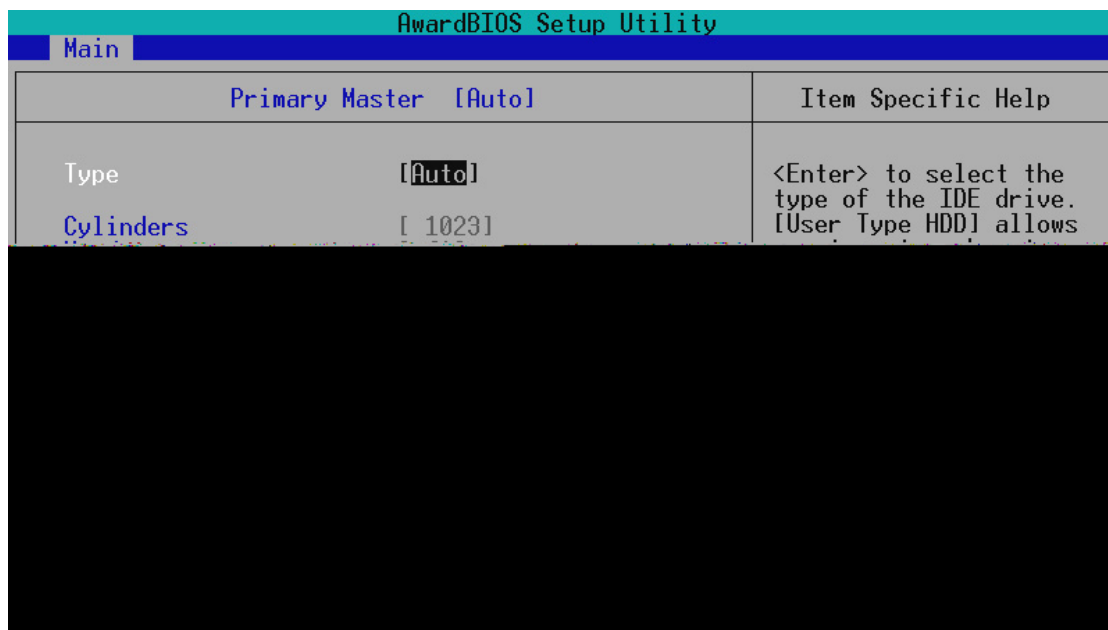

**NOTE:** Before attempting to configure a hard disk drive, make sure you have the configuration information supplied by the manufacturer of the drive. Incorrect settings may cause your system to not recognize the installed hard disk. To allow the BIOS to detect the drive type automatically, select [Auto].

### Type [Auto]

Select [Auto] to automatically detect an IDE hard disk drive. If automatic detection is successful, the correct values will be filled in for the remaining fields on this sub-menu. If automatic detection fails, your hard disk drive may be too old or too new. You can try updating your BIOS or enter the IDE hard disk drive parameters manually.

**NOTE:** After the IDE hard disk drive information has been entered into BIOS, new IDE hard disk drives must be partitioned (such as with FDISK) and then formatted before data can be read from and write on. Primary IDE hard disk drives must have its partition set to *active* (also possible with FDISK).

Other options for the **Type** field are:

-----  
**[None]** - to disable IDE devices



## 4. BIOS SETUP

**IMPORTANT:** If your hard disk was already formatted on an older previous system, incorrect parameters may be detected. You will need to enter the correct parameters manually or use low-level format if you do not need the data stored on the hard disk. If the parameters listed differ from the ones used when the disk was formatted, the disk will not be readable. If the auto-detected parameters do not match the ones that should be used for your disk, you should enter the correct ones manually by setting [User Type HDD].

### [User Type HDD]

The screenshot shows the 'AwardBIOS Setup Utility' Main screen. The 'Primary Master' drive is set to '[User Type HDD]'. The configuration options and their values are as follows:

Item	Value	Item Specific Help
Type	[User Type HDD]	<Enter> to select the type of the IDE drive. [User Type HDD] allows you to set each entry on your own.
Translation Method	[LBA]	
Cylinders	[ 1023]	
Head	[ 64]	
Sector	[63]	
CHS Capacity	2111MB	
Maximum LBA Capacity	2111MB	
Multi-Sector Transfers	[Maximum]	
SMART Monitoring	[Disabled]	
PIO Mode	[4]	
ULTRA DMA Mode	[2]	

Navigation keys at the bottom: F1 Help, ESC Exit, ↑↓ Select Item, → Select Menu, -/+ Enter, Change Values, Select Sub Menu, F5 Setup Defaults, F10 Save and Exit.

Manually enter the number of cylinders, heads and sectors per track for your drive. Refer to your drive documentation or look on the drive for this information. If no drive is installed or if you are removing a drive and not replacing it, select [None].

### Translation Method [LBA]

Select the hard disk drive type in this field. When Logical Block Addressing is enabled, 28-bit addressing of the hard drive is used without regard for cylinders, heads, or sectors. Note that Logical Block Access may decrease the access speed of the hard disk. However, LBA Mode is necessary for drives with greater than 504MB in storage capacity. Configuration options: [LBA] [LARGE] [Normal] [Match Partition Table] [Manual]

### Cylinders

This field configures the number of cylinders. Refer to your drive documentation to determine the correct value to enter into this field. **NOTE:** To make changes to this field, the **Type** field must be set to [User Type HDD] and the **Translation Method** field must be set to [Manual].



# 4. BIOS SETUP

---

## Head

This field configures the number of read/write heads. Refer to your drive documentation to determine the correct value to enter into this field. **NOTE:** To make changes to this field, the **Type** field must be set to [User Type HDD] and the **Translation Method** field must be set to [Manual].

## Sector

This field configures the number of sectors per track. Refer to your drive documentation to determine the correct value to enter into this field. **NOTE:** To make changes to this field, the **Type** field must be set to [User Type HDD] and the **Translation Method** field must be set to [Manual].

## CHS Capacity

This field shows the drive's maximum CHS capacity calculated automatically by the BIOS from the drive information you entered.

## Maximum LBA Capacity

This field shows the drive's maximum LBA capacity calculated automatically by the BIOS from the drive information you entered.

## Multi-Sector Transfers [Maximum]

This option automatically sets the number of sectors per block to the highest number supported by the drive. This field can also be configured manually. Note that when this field is automatically configured, the set value may not always be the fastest value for the drive. Refer to the documentation that came with your hard drive to determine the optimal value and set it manually. **NOTE:** To make changes to this field, the **Type** field must be set to [User Type HDD]. Configuration options: [Disabled] [2 Sectors] [4 Sectors] [8 Sectors] [16 Sectors] [32 Sectors] [Maximum]

## SMART Monitoring [Disabled]

This allows the enabling or disabling of the S.M.A.R.T. (Self-Monitoring, Analysis and Reporting Technology) system which utilizes internal hard disk drive monitoring technology. This feature is normally disabled because system resources used in this feature may decrease system performance. Configuration options: [Disabled] [Enabled]

## PIO Mode [4]

This option lets you set a PIO (Programmed Input/Output) mode for the IDE device. Modes 0 through 4 provide successively increased performance. Configuration options: [0] [1] [2] [3] [4]

## ULTRA DMA Mode [Disabled]

Ultra DMA capability allows improved transfer speeds and data integrity for compatible IDE devices. Set to [Disabled] to suppress Ultra DMA capability. **NOTE:** To make changes to this field, the **Type** field must be set to [User Type HDD]. Configuration options: [0] [1] [2] [3] [4] [Disabled]

## 4. BIOS SETUP

---

**Other options for “Type:” are:**

**[CD-ROM]** - for IDE CD-ROM drives

**[LS-120]** - for LS-120 compatible floppy disk drives

**[ZIP-100]** - for ZIP-100 compatible disk drives

**[MO]** - for IDE magneto optical disk drives

**[Other ATAPI Device]** - for IDE devices not listed here

After using the legend keys to make your selections on this sub-menu, press the <Esc> key to exit back to the Main menu. When the Main menu appears, you will notice that the drive size appear in the field for the hard disk drive that you just configured.

---

### **Language [English]**

This allows selection of the BIOS' displayed language. Configuration options: [English]

### **Supervisor Password [Disabled], User Password [Disabled]**

This field allows you to set the password. To set the password, highlight the appropriate field and press <Enter>.

Type in a password and press <Enter>. You can type up to eight alphanumeric characters. Symbols and other keys are ignored. To confirm the password, type the password again and press the <Enter>. The password is now set to [Enabled]. This password allows full access to the BIOS Setup menus.

To clear the password, highlight this field and press <Enter>. The same dialog box as above will appear. Press <Enter> and the password will be set to [Disabled].

### **A Note about Passwords**

The BIOS Setup program allows you to specify passwords in the Main menu. The passwords control access to the BIOS and certain Security menu options during system startup. The passwords are not case sensitive. In other words, it makes no difference whether you enter a password using upper or lowercase letters.

The BIOS Setup program allows you to specify two separate passwords: a Supervisor password and a User password. When disabled, anyone may access all BIOS Setup program functions. When enabled, the Supervisor password is required for entering the BIOS Setup program and having full access to all Security menu options.

# 4. BIOS SETUP

## Forgot the password?

If you forgot the password, you can clear the password by erasing the CMOS Real Time Clock (RTC) RAM. The RAM data containing the password information is powered by the onboard button cell battery. To erase the RTC RAM: (1) Unplug your computer, (2) Short the solder points, (3) Turn ON your computer, (4) Hold down <Delete> during bootup and enter BIOS setup to re-enter user preferences.

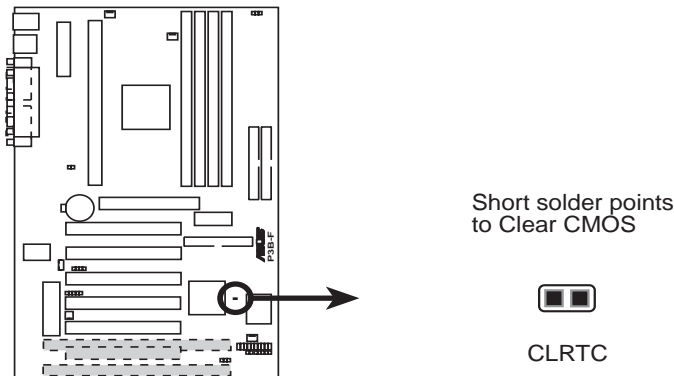

**P3B-F Clear RTC RAM**

## Halt On [All Errors]

This field determines which types of errors will cause the system to halt. Configuration options: [All Errors] [No Error] [All but Keyboard] [All but Disk] [All but Disk/Keyboard]

## Installed Memory [XXX MB]

This field displays the amount of conventional memory detected by the system during bootup. You do not need to make changes to this field. This is a display only field.

# 4. BIOS SETUP

## 4.4 Advanced Menu

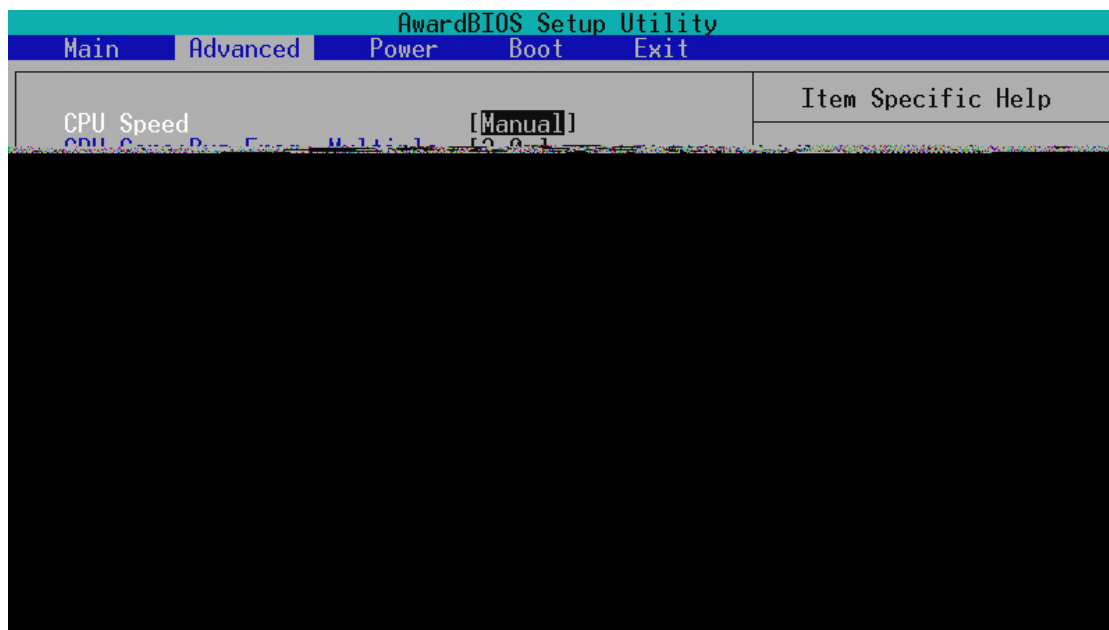

### CPU Speed [Manual]

When the motherboard is set to jumperfree mode (see **3.4 Motherboard Settings**), this field allows you to select the internal speed of your CPU. Select [Manual] if you want to make changes to the subsequent four fields. Configuration options: [Manual] [266MHz] [300MHz] [333MHz] [366MHz] [400MHz] [433MHz] [466MHz]

### CPU Core:Bus Freq. Multiple (when CPU Speed is set to [Manual])

This field sets the frequency multiple between the CPU's *internal* frequency and *external* frequency. This must be set in conjunction with **CPU Bus Frequency** to match the speed of your CPU. Configuration options: [2.0x] [2.5x] [3.0x]...[7.0x] [7.5x] [8.0x]

### CPU Bus/PCI Freq. (MHz) (when CPU Speed is set to [Manual])

This feature tells the clock generator what frequencies to send to the local bus and PCI devices onboard. The bus frequency (external frequency) multiplied by the bus multiple equals the CPU's internal frequency (the **CPU speed**).

### CPU Vcore

This field displays the core voltage supplied to the CPU. If you want to set it manually, always refer to the CPU documentation for the reasonable voltage range.

## 4. BIOS SETUP

---

### **CPU Level 1 Cache, CPU Level 2 Cache [Enabled]**

These fields allow you to choose from the default of [Enabled] or choose [Disabled] to turn on or off the CPU's Level 1 and Level 2 built-in cache. Configuration options: [Disabled] [Enabled]

### **CPU Level 2 Cache ECC Check [Disabled]**

This function controls the ECC capability in the CPU level 2 cache. Configuration options: [Disabled] [Enabled]

### **BIOS Update [Enabled]**

This functions as an update loader integrated into the BIOS to supply the processor with the required data. In the default position of [Enabled], the BIOS will load the update on all processors during system bootup. Configuration options: [Disabled] [Enabled]

### **PS/2 Mouse Function Control [Auto]**

The default of [Auto] allows the system to detect a PS/2 mouse on startup. If detected, IRQ12 will be used for the PS/2 mouse. IRQ12 will be reserved for expansion cards only if a PS/2 mouse is not detected. [Enabled] will always reserve IRQ12, whether on startup a PS/2 mouse is detected or not. Configuration options: [Enabled] [Auto]

### **USB Legacy Support [Auto]**

Configuration options: [Disabled] [Enabled] [Auto]

### **OS/2 Onboard Memory > 64M [Disabled]**

When using OS/2 operating systems with installed DRAM of greater than 64MB, you need to set this option to [Enabled]; otherwise, leave this on [Disabled]. Configuration options: [Disabled] [Enabled]

# 4. BIOS SETUP

## 4.4.1 Chip Configuration

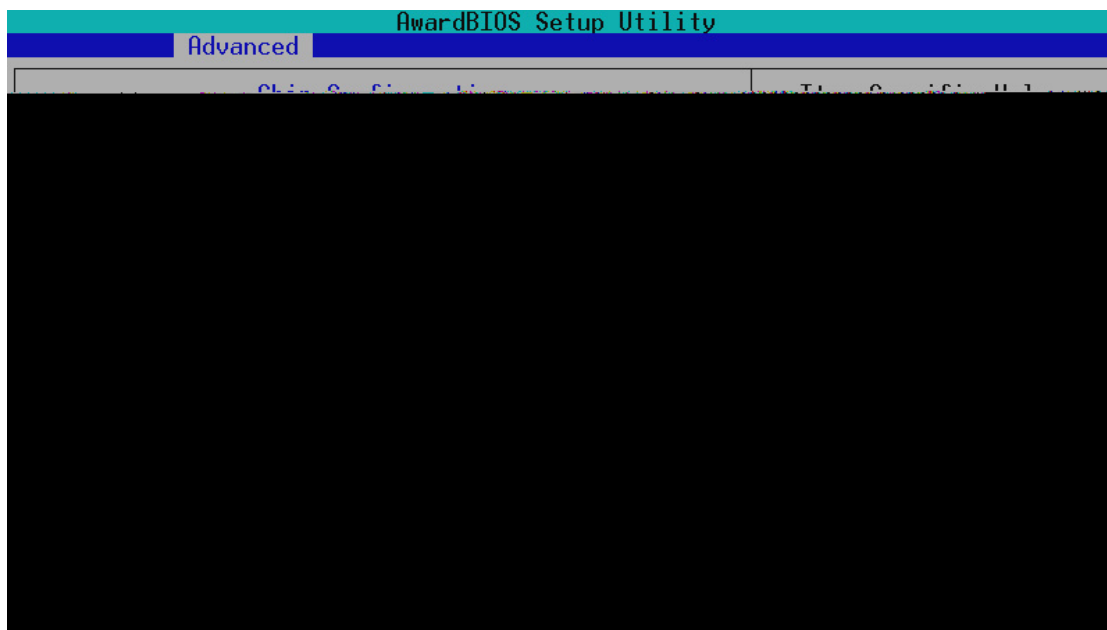

### SDRAM Configuration [By SPD]

This sets the optimal timings for items 2–4, depending on the memory modules that you are using. Default setting is [By SPD], which configures items 2–4 by reading the contents in the SPD (Serial Presence Detect) device. The EEPROM on the memory module stores critical parameter information about the module, such as memory type, size, speed, voltage interface, and module banks. Configuration options: [User Define] [7ns (143MHz)] [8ns (125MHz)] [By SPD]

### SDRAM CAS Latency

This controls the latency between the SDRAM read command and the time that the data actually becomes available. **NOTE:** To make changes to this field, the **SDRAM Configuration** field must be set to [User Define].

### SDRAM RAS to CAS Delay

This controls the latency between the SDRAM active command and the read/write command. **NOTE:** To make changes to this field, the **SDRAM Configuration** field must be set to [User Define].

### SDRAM RAS Precharge Time

This controls the idle clocks after issuing a precharge command to the SDRAM. **NOTE:** To make changes to this field, the **SDRAM Configuration** field must be set to [User Define].

### DRAM Idle Timer [10T]

This controls the amount of time in HCLKs that the DRAM controller waits to close a DRAM page after the CPU becomes idle. Leave on default setting. **NOTE:** To make changes to this field, the **SDRAM Configuration** field must be set to [User Define]. Configuration options: [0T] [2T] [4T] [8T] [10T] [12T] [16T] [32T] [Infinite]

## 4. BIOS SETUP

---

### **SDRAM MA Wait State [Normal]**

This controls the leadoff clocks for CPU read cycles. Leave on default setting. Configuration options: [Fast] [Normal] [Slow]

### **Snoop Ahead [Enabled]**

[Enabled] allows PCI streaming. Configuration options: [Enabled] [Disabled]

### **Host Bus Fast Data Ready [Disabled]**

Configuration options: [Disabled] [Enabled]

### **16-bit I/O Recovery Time [1 BUSCLK]**

Configuration options: [4 BUSCLK] [1 BUSCLK] [2 BUSCLK] [3 BUSCLK]

### **8-bit I/O Recovery Time [1 BUSCLK]**

Configuration options: [8 BUSCLK] [1 BUSCLK] [2 BUSCLK] [3 BUSCLK] [4 BUSCLK] [5 BUSCLK] [6 BUSCLK] [7 BUSCLK]

### **Graphics Aperture Size [64MB]**

This feature allows you to select the size of mapped memory for AGP graphic data. Configuration options: [4MB] [8MB] [16MB] [32MB] [64MB] [128MB] [256MB]

### **Video Memory Cache Mode [UC]**

USWC (uncacheable, speculative write combining) is a new cache technology for the video memory of the processor. It can greatly improve the display speed by caching the display data. You must set this to UC (uncacheable) if your display card cannot support this feature; otherwise your system may not boot. Configuration options: [UC] [USWC]

### **PCI 2.1 Support [Enabled]**

This function allows you to enable or disable PCI 2.1 features including passive release and delayed transaction. Configuration options: [Disabled] [Enabled]

### **Memory Hole At 15M-16M [Disabled]**

This field allows you to reserve an address space for ISA expansion cards that require it. Configuration options: [Disabled] [Enabled]

### **Onboard PCI IDE Enable [Both]**

You can select to enable the primary IDE channel, secondary IDE channel, both, or disable both channels. Configuration options: [Both] [Primary] [Secondary] [Disabled]

### **Data Integrity Mode [Non-ECC]**

[Non-ECC] has byte-wise write capability but no provision for protecting data integrity in the DRAM array. When [EC-Only] is selected, data errors are detected but not corrected. [ECC] with hardware scrubbing allows the detection of single-bit and multiple-bit errors and recovery of single-bit errors. This field is available only if your DIMMs have ECC. Configuration options: [Non-ECC] [EC-Only] [ECC]



# 4. BIOS SETUP

## 4.4.2 I/O Device Configuration

AwardBIOS Setup Utility	
Advanced	
I/O Device Configuration	Item Specific Help
Onboard FDC Swap A & B [No Swap] Floppy Disk Access Control [R/W]	<Enter> to select whether or not to switch drive letter assignments.
Onboard Serial Port 1 [3F8H/IRQ4] Onboard Serial Port 2 [2F8H/IRQ3] UART2 Use Infrared [Disabled]	
Onboard Parallel Port [378H/IRQ7] Parallel Port Mode [ECP+EPP] ECP DMA Select [3]	

F1 Help ↑↓ Select Item -/+ Change Values F5 Setup Defaults  
ESC Exit ↔ Select Menu Enter Select ► Sub-Menu F10 Save and Exit

### Onboard FDC Swap A & B [No Swap]

This field allows you to reverse the hardware drive letter assignments of your floppy disk drives. Configuration options: [No Swap] [Swap AB]

### Floppy Disk Access Control [R/W]

When set to [Read Only], this field protects files from being copied to floppy disks by allowing reads from the floppy disk drive but not writes. The setup default [R/W] allows both reads and writes. Configuration options: [R/W] [Read Only]

### Onboard Serial Port 1 [3F8H/IRQ4], Onboard Serial Port 2 [2F8H/IRQ3]

These fields allow you to set the addresses for the onboard serial connectors. Serial Port 1 and Serial Port 2 must have different addresses. Configuration options: [3F8H/IRQ4] [2F8H/IRQ3] [3E8H/IRQ4] [2E8H/IRQ10] [Disabled]

### UART2 Use Infrared [Disabled]

When enabled, this field activates the onboard infrared feature and sets the second serial UART to support the infrared module connector on the motherboard. If your system already has a second serial port connected to the onboard COM2 connector, it will no longer work if you enable the infrared feature. See **IrDA-Compliant Infrared Module Connector** in *3.8 External Connectors*. Configuration options: [Disabled] [Enabled]



## 4. BIOS SETUP

---

### **Onboard Parallel Port [378H/IRQ7]**

This field sets the address of the onboard parallel port connector. If you disable this feature, **Parallel Port Mode** and **ECP DMA Select** configurations will not be available. Configuration options: [Disabled] [378H/IRQ7] [278H/IRQ5]

### **Parallel Port Mode [ECP+EPP]**

This field allows you to set the operation mode of the parallel port. [Normal] allows normal-speed operation but in one direction only; [EPP] allows bidirectional parallel port operation; [ECP] allows the parallel port to operate in bidirectional DMA mode; [ECP+EPP] allows normal speed operation in a two-way mode. Configuration options: [Normal] [EPP] [ECP] [ECP+EPP]

### **ECP DMA Select [3]**

This field allows you to configure the parallel port DMA channel for the selected **ECP** mode. This selection is available only if you select [ECP] or [ECP+EPP] in **Parallel Port Mode** above. Configuration options: [1] [3] [Disabled]

# 4. BIOS SETUP

## 4.4.3 PCI Configuration

AwardBIOS Setup Utility		
Advanced		
PCI Configuration	Item Specific Help	
Slot 1 IRQ	[Auto]	<Enter> to select an IRQ.
Slot 2 IRQ	[Auto]	
Slot 3/6 IRQ	[Auto]	
Slot 4/5 IRQ	[Auto]	
PCI/VGA Palette Snoop	[Disabled]	
PCI Latency Timer	[ 32]	
SYMBIOS SCSI BIOS	[Auto]	
USB IRQ	[Enabled]	
VGA BIOS Sequence	[PCI/AGP]	
▶ PCI/PNP ISA IRQ Resource Exclusion		
▶ PCI/PNP ISA DMA Resource Exclusion		
▶ PCI/PNP ISA UMB Resource Exclusion		

F1 Help   ↑ Select Item   ← Change Values   F5 Setup Defaults

### Slot 1 IRQ, Slot 2 IRQ, Slot 3/6 IRQ, Slot 4/5 IRQ [Auto]

These fields set how IRQ use is determined for each PCI slot. The default setting for each field is [Auto], which uses auto-routing to determine IRQ use. Configuration options: [Auto] [NA] [3] [4] [5] [7] [9] [10] [11] [12] [14] [15]

### PCI/VGA Palette Snoop [Disabled]

Some nonstandard VGA cards, such as graphics accelerators or MPEG Video Cards, may not show colors properly. The setting [Enabled] should correct this problem. Otherwise, leave this on the default setting of [Disabled]. Configuration options: [Disabled] [Enabled]

### PCI Latency Timer [32]

Leave on default setting for best performance vs. stability.

### SYMBIOS SCSI BIOS [Auto]

[Auto] allows the motherboard's BIOS to detect whether you have a Symbios SCSI card. If the Symbios SCSI card is detected, the motherboard's Symbios BIOS will be enabled; if no Symbios SCSI card is detected, the onboard Symbios SCSI BIOS will be disabled.

[Disabled] will disable the motherboard's Symbios SCSI BIOS so that the BIOS on an external Symbios SCSI card can be used. If your Symbios SCSI card does not have a BIOS, the Symbios SCSI card will not function. Configuration options: [Auto] [Disabled]

# 4. BIOS SETUP

## USB IRQ [Enabled]

[Enabled] reserves an IRQ# for the USB to work. [Disabled] does not allow the USB to have an IRQ# and therefore prevents the USB from functioning. If you are not using any USB devices, you may set this feature to [Disabled] to save an extra IRQ# for expansion cards. Configuration options: [Disabled] [Enabled]

## VGA BIOS Sequence [PCI/AGP]

If your computer has both PCI and AGP VGA cards, this field allows you to select which of the cards will act as your primary card. The default, [PCI/AGP], allows your PCI card to take precedent when detected. [AGP/PCI] uses the AGP card as your primary card. Configuration options: [PCI/AGP] [AGP/PCI]

## PCI/PNP ISA IRQ Resource Exclusion

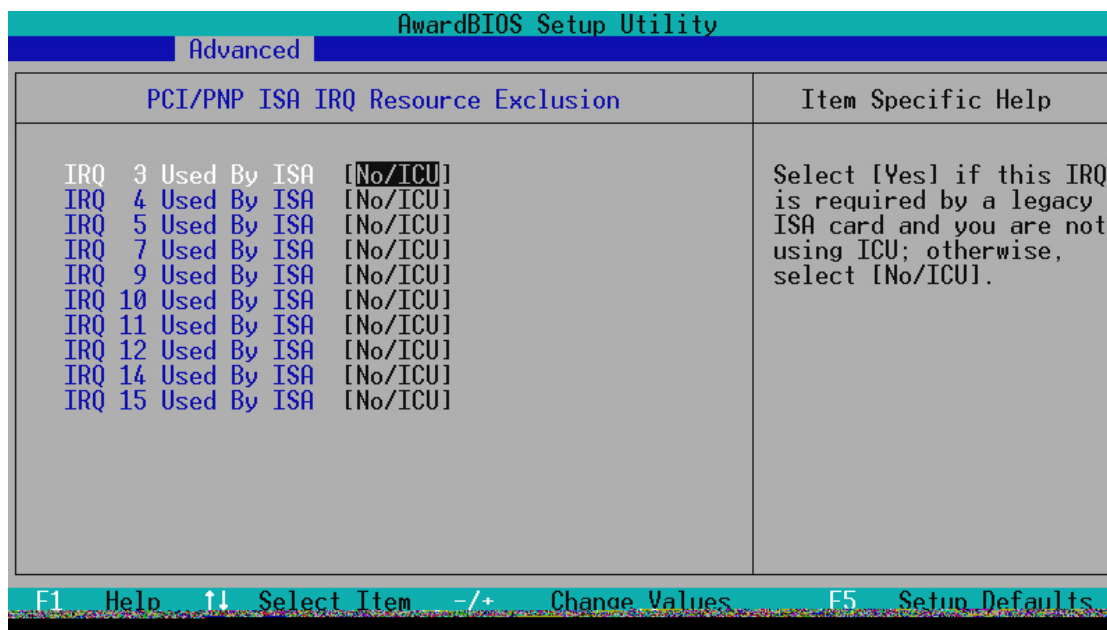

4. BIOS SETUP  
PCI Configuration

## IRQ XX Used By ISA [No/ICU]

These fields indicate whether or not the displayed IRQ for each field is being used by a legacy (non-PnP) ISA card. The default value indicates either that the displayed IRQ is not used or that ISA Configuration Utility (ICU) is being used to determine if an ISA card is using that IRQ. If you install a legacy ISA card that requires a unique IRQ and you are not using an ICU, you must set the field for that IRQ to [Yes]. For example: If you install a legacy ISA card that requires IRQ 10, then set **IRQ10 Used By ISA** to [Yes]. Configuration options: [No/ICU] [Yes]

# 4. BIOS SETUP

## PCI/PNP ISA DMA Resource Exclusion

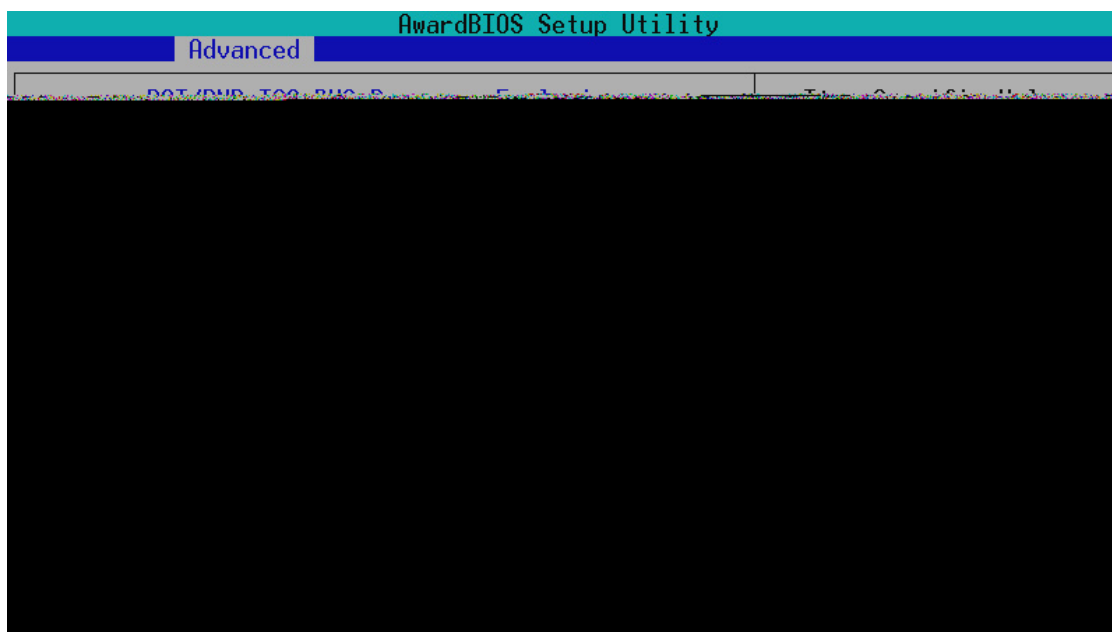

### DMA x Used By ISA [No/ICU]

These fields indicate whether or not the displayed DMA channel for each field is being used by a legacy (non-PnP) ISA card. The default setting indicates either that the displayed DMA channel is not used or an ICU is being used to determine if an ISA card is using that channel. If you install a legacy ISA card that requires a unique DMA channel, and you are not using an ICU, you must set the field for that channel to [Yes]. Configuration options: [No/ICU] [Yes]

## PCI/PNP ISA UMB Resource Exclusion

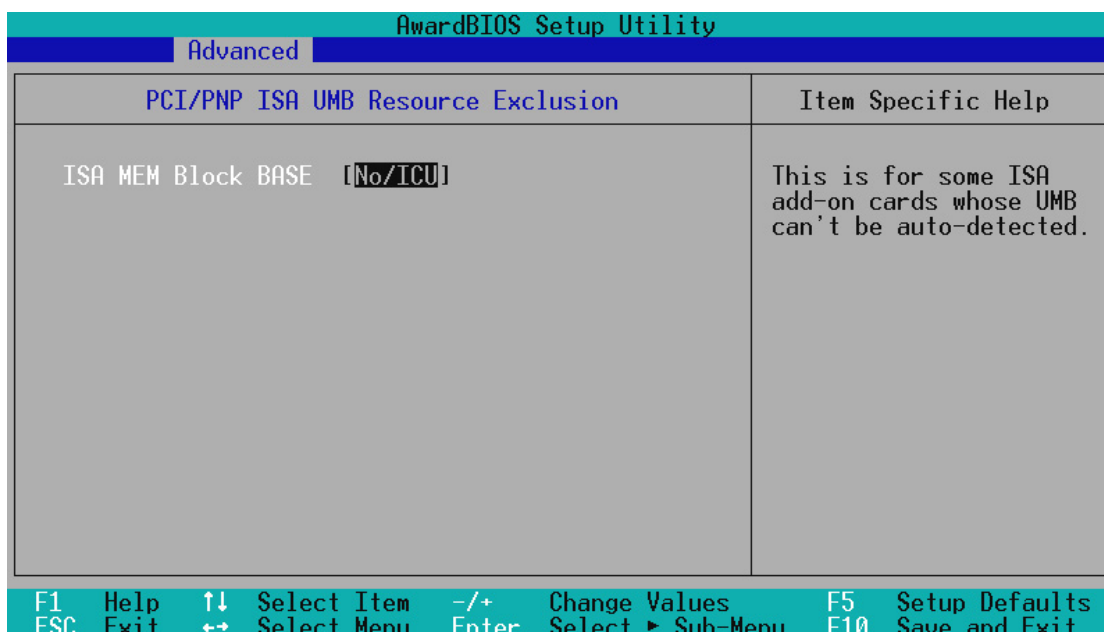

# 4. BIOS SETUP

## ISA MEM Block BASE [No/ICU]

This field allows you to set the base address and block size of a legacy ISA card that uses any memory segment within the C800 and DFFF address range. If you have such a card and you are not using an ICU to specify its address range, select a base address from the six available options; the **ISA MEM Block SIZE** field will then appear for selecting the block size. If you have more than one legacy ISA card in your system that requires the use of this address range, you can increase the block size to 8K, 16K, 32K, or 64K. If you are using an ICU to accomplish this task, leave **ISA MEM Block BASE** to its default setting of [No/ICU]. Configuration options: [No/ICU] [C800] [CC00] [D000] [D400] [D800] [DC00]

## 4.4.4 Shadow Configuration

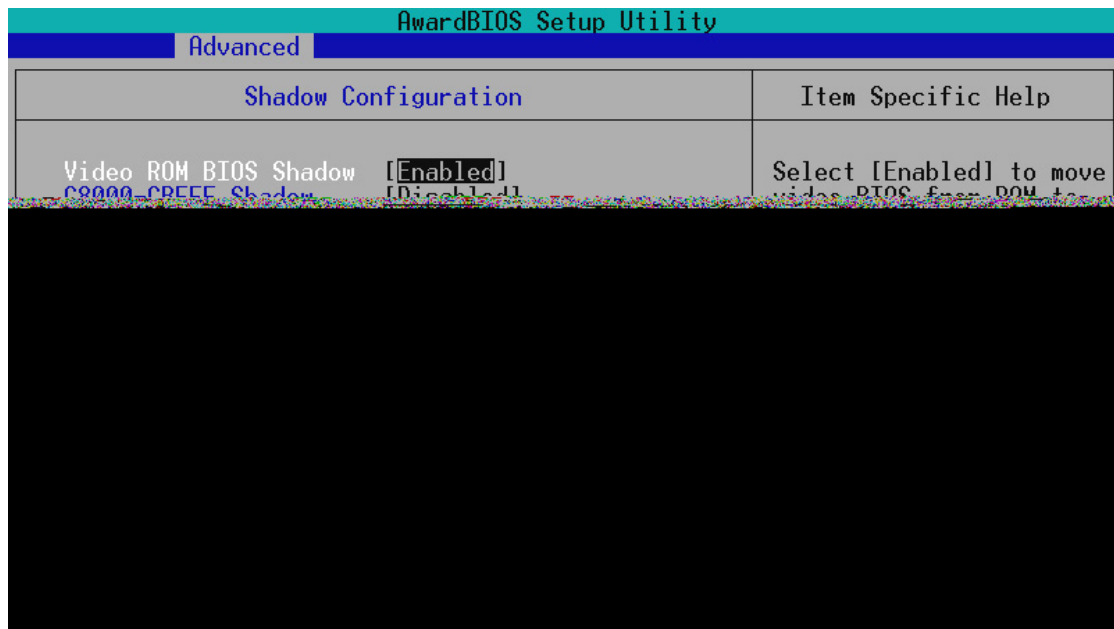

### Video ROM BIOS Shadow [Enabled]

This field allows you to change the video BIOS location from ROM to RAM. Relocating to RAM enhances system performance, as information access is faster than the ROM. Configuration options: [Disabled] [Enabled]

### C8000-DFFFF Shadow [Disabled]

These fields are used for shadowing other expansion card ROMs. If you install other expansion cards with ROMs on them, you will need to know which addresses the ROMs use to shadow them specifically. Shadowing a ROM reduces the memory available between 640K and 1024K by the amount used for this purpose. Configuration options: [Disabled] [Enabled]

# 4. BIOS SETUP

## 4.5 Power Menu

The Power menu allows you to reduce power consumption. This feature turns off the video display and shuts down the hard disk after a period of inactivity.

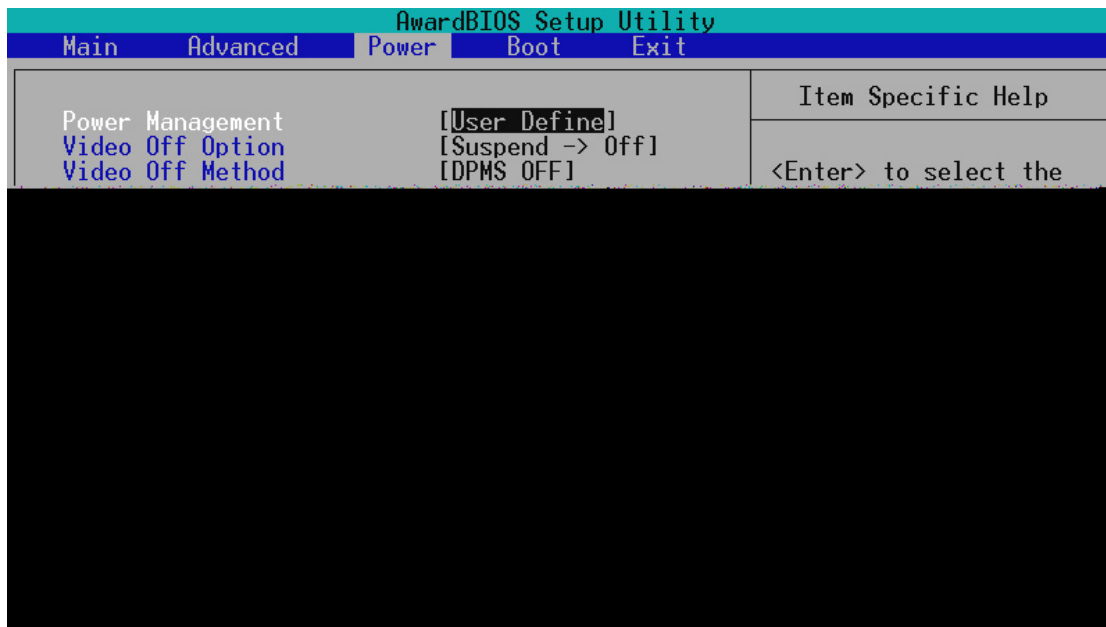

### Power Management [User Define]

This option must be enabled to use any of the automatic power saving features. If this menu item is set to [Disabled], power management features will not function regardless of other field settings on this menu. The [User Define] option allows you to make your own selections in the Power menu. When set to [Max Saving], system power will be conserved to its greatest amount. The **Suspend Mode** field will then be set to predefined value that ensures maximum power savings.

This field acts as the master control for the power management modes. [Max Saving] puts the system into power saving mode after a brief period of system inactivity; [Min Saving] is almost the same as [Max Saving] except that the system inactivity period is longer; [Disabled] disables the power saving features; [User Define] allows you to set power saving options according to your preference. Configuration options: [User Define] [Disabled] [Min Saving] [Max Saving]

**IMPORTANT:** Advanced Power Management (APM) should be installed to keep the system time updated when the computer enters suspend mode activated by the BIOS Power Management. For DOS environments, you need to add the statement, DEVICE=C:\DOS\POWER.EXE, to your CONFIG.SYS file. For Windows 3.x and Windows 95, you need to install Windows with the APM feature. For Windows 98 and later, APM is automatically installed. A battery and power cord icon labeled “Power Management” will appear in the “Control Panel.” Choose “Advanced” in the Power Management Properties dialog box.



## 4. BIOS SETUP

---

### **Video Off Option [Suspend -> Off ]**

This field determines when to activate the video off feature for monitor power management. Configuration options: [Always On] [Suspend -> Off]

### **Video Off Method [DPMS OFF]**

This field defines the video off features. The DPMS (Display Power Management System) feature allows the BIOS to control the video display card if it supports the DPMS feature. [Blank Screen] only blanks the screen. (Use this for monitors without power management or “green” features. Your screen saver will not display with [Blank Screen] selected). [V/H SYNC+Blank] blanks the screen and turns off vertical and horizontal scanning. Configuration options: [Blank Screen] [V/H SYNC+Blank] [DPMS Standby] [DPMS Suspend] [DPMS OFF] [DPMS Reduce ON]

### **HDD Power Down [Disabled]**

When enabled, this shuts down any IDE hard disk drives in the system after a period of inactivity as set in this user-configurable field. This feature does not affect SCSI hard drives. Configuration options: [Disabled] [1 Min] [2 Min] [3 Min]...[15 Min]

### **Suspend-to-RAM Capability [Disabled]**

Suspend-to-RAM (STR) is an updated energy-saving feature and requires the system be set up to support ACPI. In Suspend-to-RAM state, all devices on the computer are turned off, except for the system RAM. Thus, the PC consumes less than 5 Watts of power. [Auto] allows the BIOS to detect if your power supply can supply at least 720mA on the +5VSB lead to support the STR function. If the power supply meets the requirement, the STR function will be enabled; if not, this function will be disabled. If your expansion cards do not support the STR function, you must leave this field on the default setting of [Disabled]. **NOTE:** This field is only effective for DOS, Windows 95, and Windows NT 4.0 environments. Configuration options: [Auto] [Disabled]

### **Suspend Mode [Disabled]**

Sets the time period before the system goes into suspend mode. **NOTE:** This field is only effective for DOS, Windows 95, and Windows NT 4.0 environments. Configuration options: [Disabled] [30 Sec] [1 Min] [2 Min] [4 Min] [8 Min] [20 Min] [40 Min]

### **PWR Button < 4 Secs [Soft off]**

When set to [Soft off], the ATX switch can be used as a normal system power-off button when pressed for less than 4 seconds. [Suspend] allows the button to have a dual function where pressing less than 4 seconds will place the system in sleep mode. Regardless of the setting, holding the ATX switch for more than 4 seconds will power off the system. **NOTE:** This field is only effective in APM OS system. Configuration options: [Soft off] [Suspend]

# 4. BIOS SETUP

## 4.5.1 Power Up Control

AwardBIOS Setup Utility	
Power	
Power Up Control	Item Specific Help
AC PWR Loss Restart [Disabled]	<Enter> to select whether or not to restart the system after AC power loss.
PWR Up On Modem Act [Enabled]	
Wake On LAN [Disabled]	
PWR Up On PS2 KB/Mouse [Disabled]	

### AC PWR Loss Restart [Disabled]

This allows you to set whether you want your system to reboot after the power has been interrupted. [Disabled] leaves your system off and [Enabled] reboots your system if it was active before power loss. Configuration options: [Disabled] [Enabled]

### PWR Up On Modem Act [Enabled]

This allows either settings of [Enabled] or [Disabled] for powering up the computer when the modem receives a call while the computer is in Soft-off mode. **NOTE:** The computer cannot receive or transmit data until the computer and applications are fully running, thus connection cannot be made on the first try. Turning an external modem off and then back on while the computer is off causes an initialization string that will also cause the system to power on. Configuration options: [Disabled] [Enabled]

### Wake On LAN [Disabled]

Wake-On-LAN allows your computer to be booted from another computer via a network by sending a wake-up frame or signal. Configuration options: [Disabled] [Enabled]

**IMPORTANT:** This feature requires an optional network interface with Wake-On-LAN and an ATX power supply with at least 720mA +5V standby power.



## 4. BIOS SETUP

---

### **PWR Up On PS2 KB/Mouse [Disabled]**

Set this field to [Enabled] if you wish to use your PS2 keyboard (by pressing the spacebar) or PS2 mouse (by clicking on the left button) to power up your computer. This feature requires an ATX power supply that can supply at least 300mA on the +5VSB lead. The default is set to [Disabled] because not all computers have the appropriate ATX power supply. Your computer will not power ON if you set this to [Enabled] and do not have the appropriate ATX power supply. Configuration options: [Disabled] [Enabled]

### **Automatic Power Up [Disabled]**

This allows an unattended or automatic system power up. You may configure your system to power up at a certain time of the day by selecting [Everyday] or at a certain time and day by selecting [By Date]. Configuration options: [Disabled] [Everyday] [By Date]

# 4. BIOS SETUP

## 4.5.2 Hardware Monitor

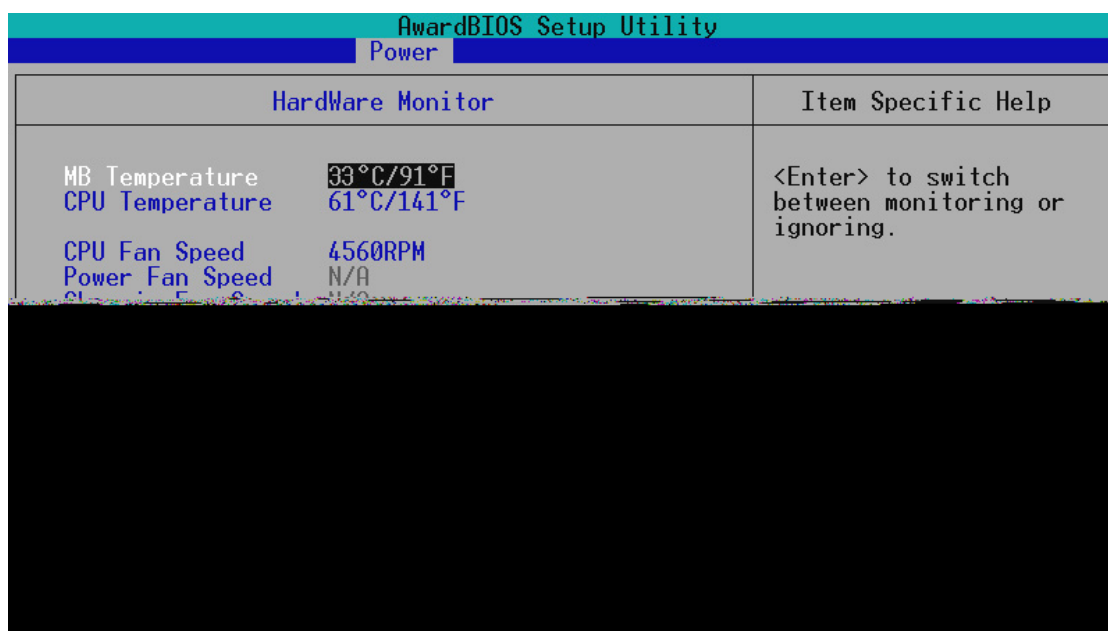

### MB Temperature, CPU Temperature [xxxC/xxxF]

The onboard hardware monitor is able to detect the MB (motherboard) and CPU temperatures. Set to [Ignore] only if necessary.

### Chassis Fan, CPU Fan, Power Fan Speed [xxxxRPM]

The onboard hardware monitor is able to detect the CPU fan speed, power supply fan speed, and the chassis fan speed in rotations per minute (RPM). The presence of the fans is automatically detected. Set to [Ignore] only if necessary.

### VCORE Voltage, +3.3V Voltage, +5V Voltage, +12V Voltage, -12V Voltage, -5V Voltage [xx.xV]

The onboard hardware monitor is able to detect the voltage output by the onboard voltage regulators. Set to [Ignore] only if necessary.

**NOTE:** If any of the monitored items is out of range, an error message will appear: “Hardware Monitor found an error. Enter Power setup menu for details”. You will then be prompted to “Press **F1** to continue, **DEL** to enter SETUP”.

# 4. BIOS SETUP

## 4.6 Boot Menu

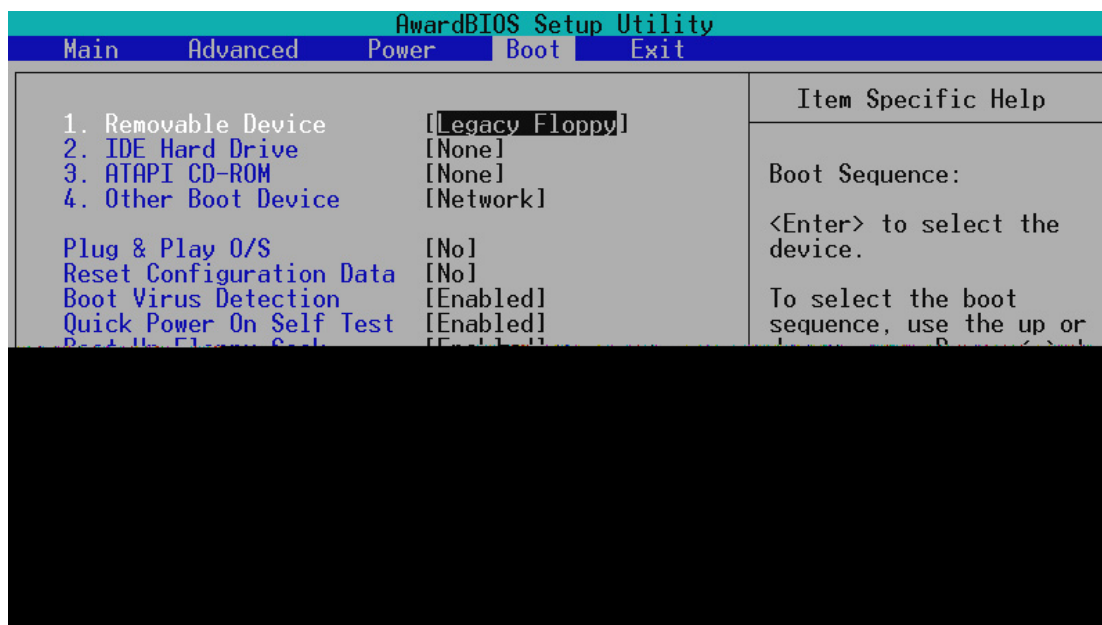

### Boot Sequence

The Boot menu allows you to select among the four possible types of boot devices listed using the up and down arrow keys. By using the <+> or <Space> key, you can promote devices and by using the <-> key, you can demote devices. Promotion or demotion of devices alters the priority which the system uses to search for a boot device on system power up. Configuration options: [Removable Devices] [IDE Hard Drive] [ATAPI CD-ROM] [Other Boot Device]

### Removable Device [Legacy Floppy]

Configuration options: [Legacy Floppy] [LS120] [ZIP-100] [ATAPI MO]

### IDE Hard Drive

This field allows you to select which IDE hard disk drive to use in the boot sequence. Pressing [Enter] will show the product IDs of all connected IDE hard disk drives.

### ATAPI CD-ROM

This field allows you to select which ATAPI CD-ROM drive to use in the boot sequence. Pressing [Enter] will show the product IDs of all your connected ATAPI CD-ROM drives.

### Other Boot Device Select [Network]

Configuration options: [Network] [SCSI Boot Device]

## 4. BIOS SETUP

---

### **Plug & Play O/S [No]**

This field allows you to use a Plug-and-Play (PnP) operating system to configure the PCI bus slots instead of using the BIOS. When [Yes] is selected, interrupts may be reassigned by the OS. When a non-PnP OS is installed or you want to prevent reassigning of interrupt settings, select the default setting of [No]. Configuration options: [No] [Yes]

### **Reset Configuration Data [No]**

Configuration options: [No] [Yes]

### **Boot Virus Detection [Enabled]**

Configuration options: [Disabled] [Enabled]

### **Quick Power On Self Test [Enabled]**

Configuration options: [Disabled] [Enabled]

### **Boot Up Floppy Seek [Enabled]**

Configuration options: [Disabled] [Enabled]

### **Boot Up NumLock Status [On]**

Configuration options: [Off] [On]

### **Full Screen Logo [Enabled]**

Configuration options: [Disabled] [Enabled]

# 4. BIOS SETUP

## 4.7 Exit Menu

Once you have made all of your selections from the various menus in the Setup program, you should save your changes and exit Setup. Select **Exit** from the menu bar to display the following menu:

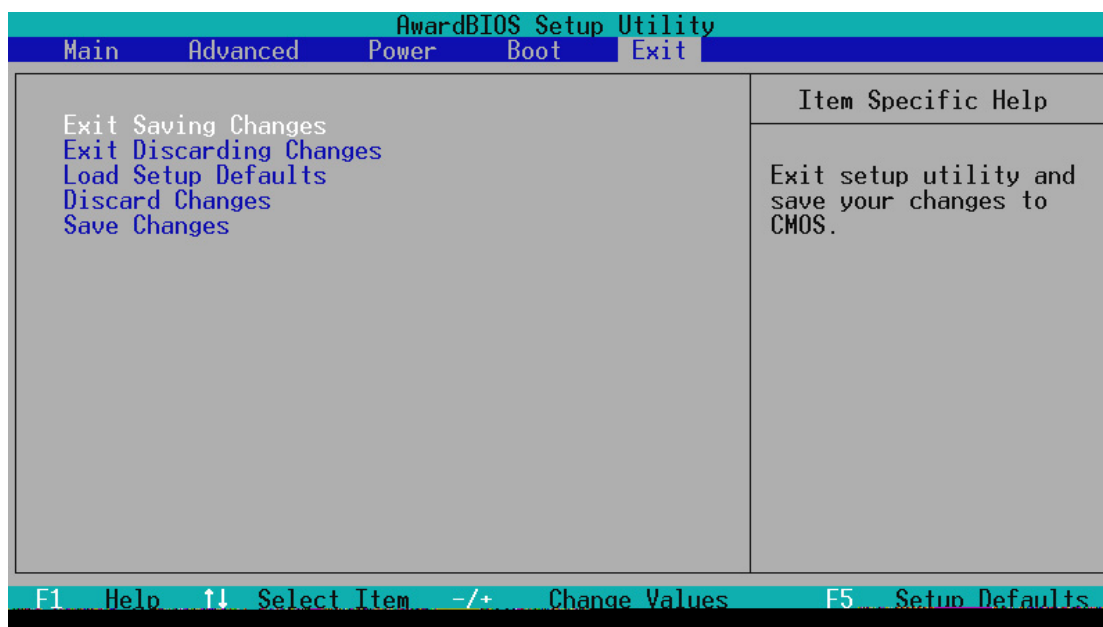

**NOTE:** Pressing <Esc> does not exit this menu. You must select one of the options from this menu or <F10> from the legend bar to exit this menu.

### Exit Saving Changes

Once you are finished making your selections, choose this option from the Exit menu to ensure the values you selected are saved to the CMOS RAM. The CMOS RAM is sustained by an onboard backup battery and stays on even when the PC is turned off. Once this option is selected, a confirmation is asked. Select [Yes] to save changes and exit.

**NOTE:** If you attempt to exit the Setup program without saving your changes, the program will prompt you with a message asking if you want to save your changes before exiting. Pressing <Enter> will then save changes while exiting.

### Exit Discarding Changes

This option should only be used if you do not want to save the changes you have made to the Setup program. If you have made changes to fields other than system date, system time, and password, the system will ask for confirmation before exiting.

## 4. BIOS SETUP

---

### **Load Setup Defaults**

This option allows you to load the default values for each of the parameters on the Setup menus. When this option is selected or if <F5> is pressed, a confirmation is requested. Select [Yes] to load default values. You can now select **Exit Saving Changes** or make other changes before saving the values to the non-volatile RAM.

### **Discard Changes**

This option allows you to discard the selections you made and restore the values you previously saved. After selecting this option, a confirmation is requested. Select [Yes] to discard any changes and load the previously saved values.

### **Save Changes**

This option saves your selections without exiting the Setup program. You can then return to other menus and make changes. After selecting this option, all selections are saved and a confirmation is requested. Select [Yes] to save any changes to the non-volatile RAM.

# 5. SOFTWARE SETUP

## 5.1 Operating Systems

You should always use the latest operating system and updates when using new hardware to ensure full compliancy. For Windows 95, you must use OSR 2.0 or later. For Windows NT 4.0, you must use Service Pack 3.0 or later.

## 5.2 P3B-F Support CD

**NOTE:** The support CD contents are subject to change at any time without notice.

To begin using your support CD disc, just insert it into your CD-ROM drive and the support CD installation menu should appear. If the menu does not appear, double-click or run **D:\SETUP.EXE** (assuming that your CD-ROM drive is drive **D:**).

### 5.2.1 Installation Menu

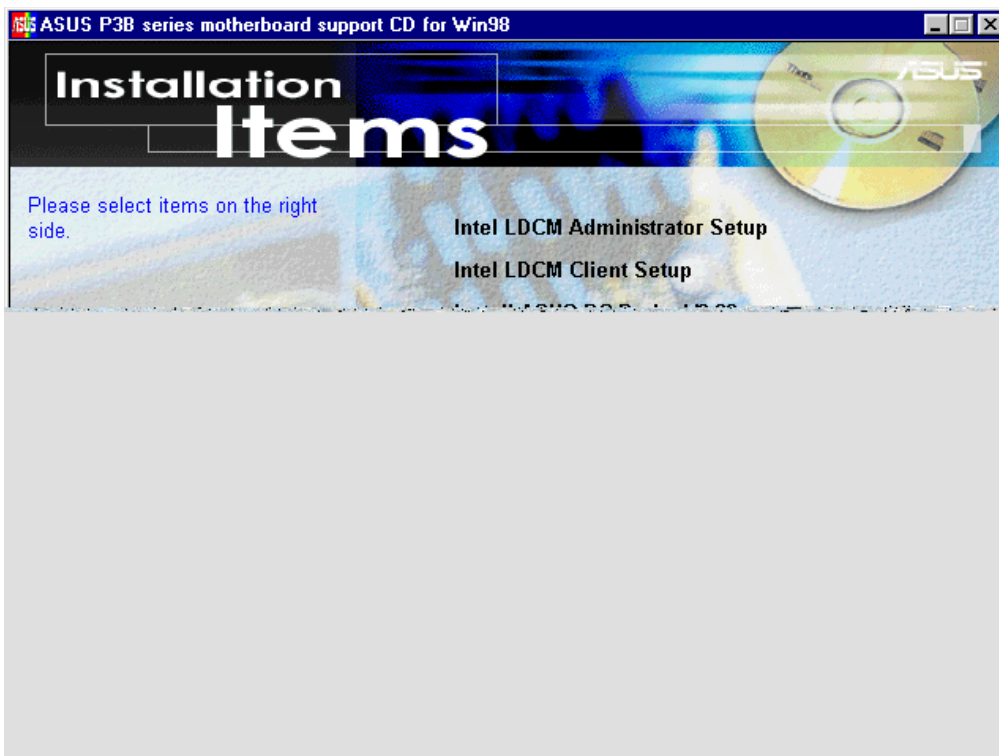

- **Intel LDCM Administrator Setup:** Installs software to monitor PC systems on the network within the same bridge address with the Client software installed. The administrator should install both Client and Administrator Software.
- **Intel LDCM Client Setup:** Installs software to monitor PC systems on the local system. The LANDesk Client Manager must be installed in order to use the hardware manager features.
- **Install ASUS PC Probe Vx.xx:** Installs a simple utility to monitor your computer's fan, temperature, and voltages.
- **Install ASUS Update Vx.xx:** Installs a program to help you update your BIOS or download a BIOS image file.

# 5. SOFTWARE SETUP

---

- **Install PCCillin 98 Vx.xx:** Installs the PC-cillin virus protection software. View the online help for more information.
- **Install ADOBE Acrobat Reader Vx.x:** Installs the Adobe Acrobat Reader software necessary to view user's manuals saved in PDF format. Updated or other language versions of this motherboard's manual is available in PDF format at any of our web sites.
- **Show Motherboard Information:** Allows you to view information about your motherboard, such as product name, BIOS version, and CPU.
- **Browse Support CD:** Allows you to view the contents of the CD.
- **ReadMe:** Displays the filelist for the included support software.
- **Exit:** Exits the CD installation menu. (Click RIGHT ARROW on the lower-right corner of the main menu.)

**Additional CD Contents:** DMI Configuration Utility in the **DMI** folder, Flash BIOS writer in the **AFLASH** folder, IDE Bus Master driver for improved performance under Windows NT in the **BUSMASTR** folder, USB patch to fix problems when using the USB driver under Windows 95 OSR 2.1 in the **USBPATCH** folder.

**NOTE:** The screen displays in this and the following section may not reflect exactly the screen contents displayed on your screen.



# 5. SOFTWARE SETUP

## 5.3 Intel LDCM Administrator Setup

Insert the Support CD that came with your motherboard into your CD-ROM drive or double-click the CD drive icon in **My Computer** to bring up the setup screen.

**NOTE:** Intel LDCM will not run if another hardware monitoring utility is installed. To uninstall any program, see *5.9 Uninstalling Programs*.

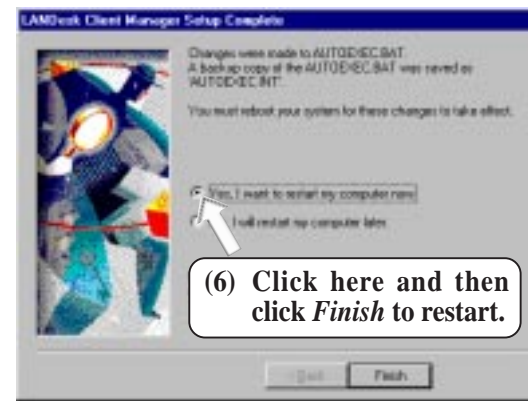
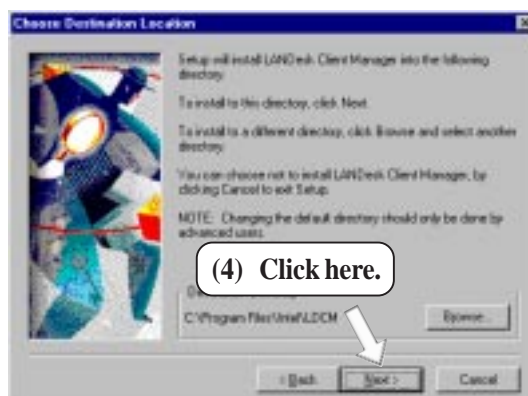
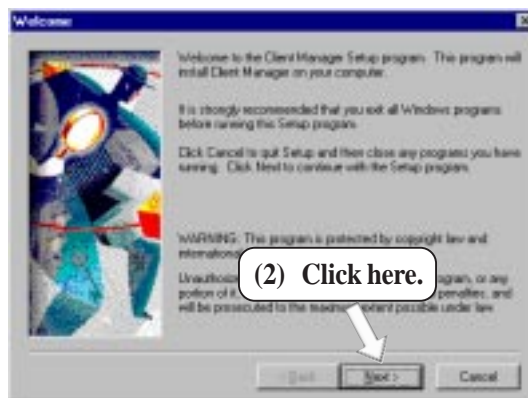

# 5. SOFTWARE SETUP

## 5.4 Intel LDCM Client Setup

Insert the Support CD that came with your motherboard into your CD-ROM drive or double-click the CD drive icon in **My Computer** to bring up the setup screen.

**NOTE:** Intel LDCM will not run if another hardware monitoring utility is installed. To uninstall any program, see *5.9 Uninstalling Programs*.

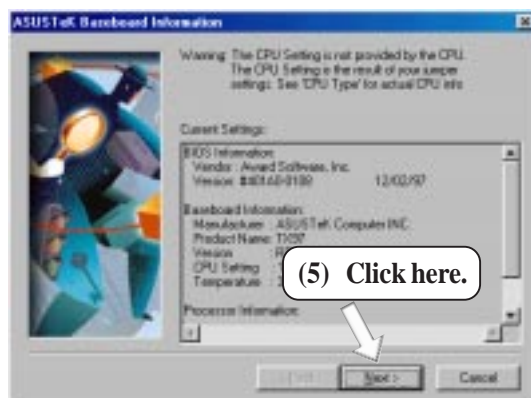
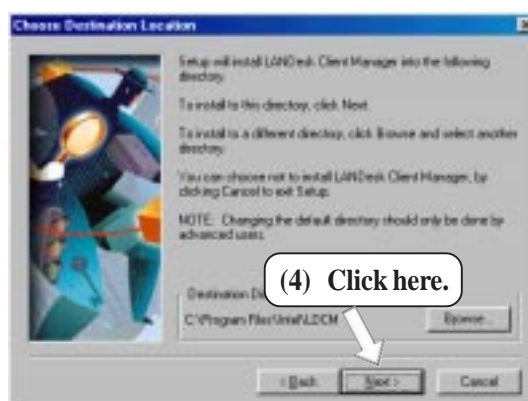
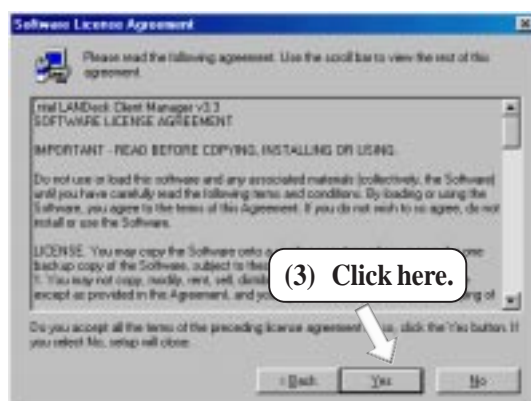

# 5. SOFTWARE SETUP

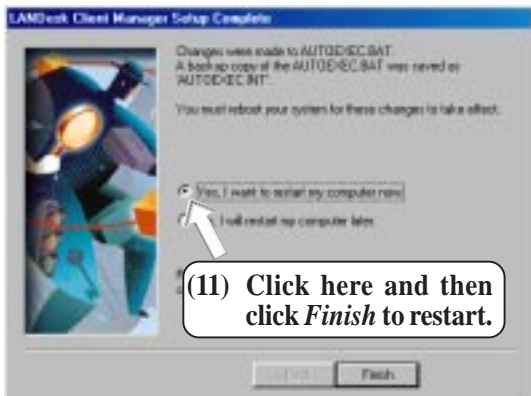
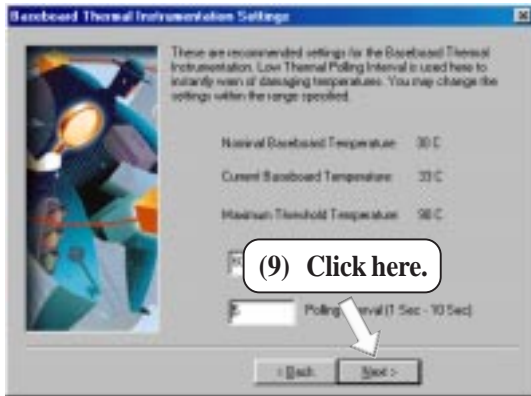
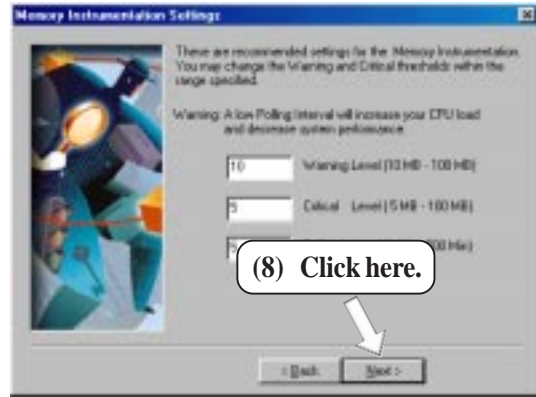



# 5. SOFTWARE SETUP

## 5.5 Install ASUS PC Probe Vx.xx

Insert the Support CD that came with your motherboard into your CD-ROM drive or double-click the CD drive icon in **My Computer** to bring up the setup screen.

**NOTE:** ASUS PC Probe will not run if another hardware monitoring utility is installed. To uninstall any program, see *5.9 Uninstalling Programs*.

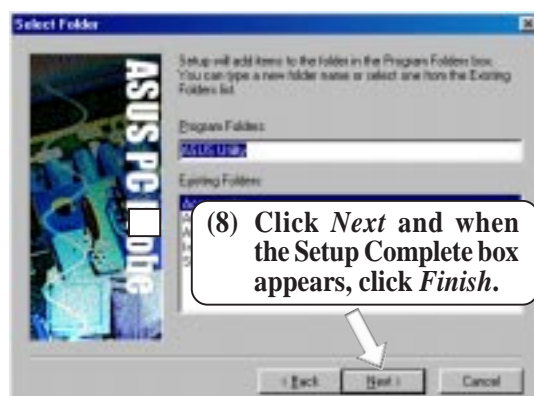
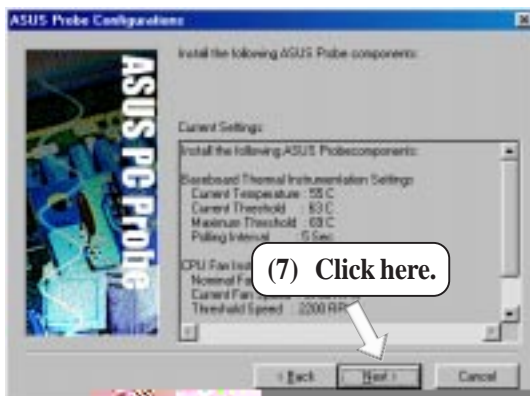
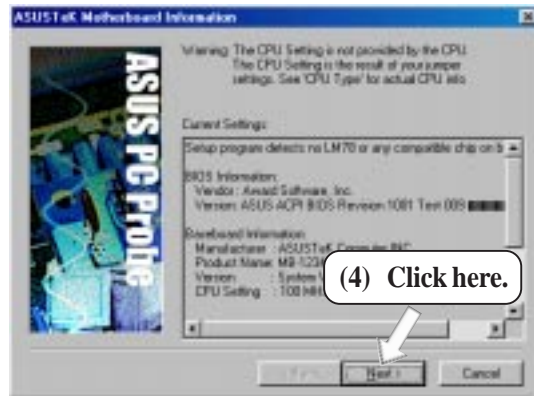
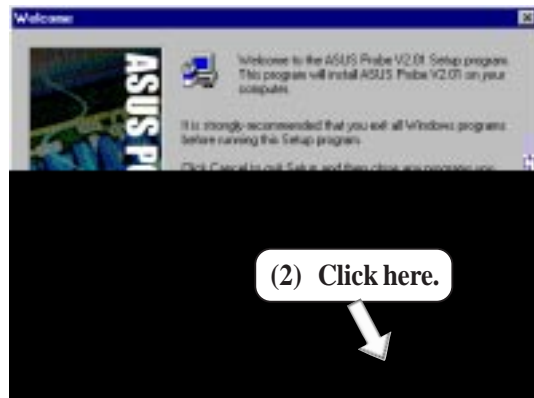

# 5. SOFTWARE SETUP

## 5.6 Install ASUS Update Vx.xx

Insert the Support CD that came with your motherboard into your CD-ROM drive or double-click the CD drive icon in **My Computer** to bring up the setup screen.

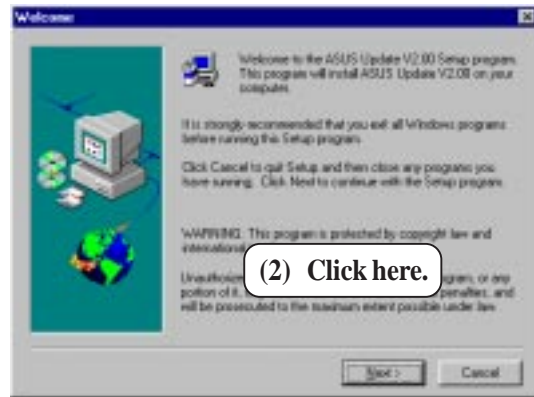

# 5. SOFTWARE SETUP

## 5.7 Install PC-Cillin 98 Vx.xx

Insert the Support CD that came with your motherboard into your CD-ROM drive or double-click the CD drive icon in **My Computer** to bring up the setup screen.

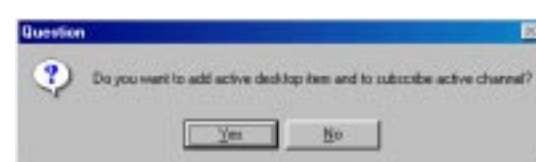

(6) & (7) Select the preferred features by clicking the appropriate buttons.

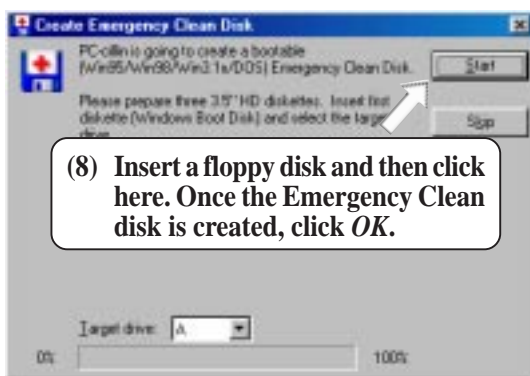



# 5. SOFTWARE SETUP

## 5.8 Install ADOBE Acrobat Reader Vx.x

Insert the Support CD that came with your motherboard into your CD-ROM drive or double-click the CD drive icon in **My Computer** to bring up the setup screen.

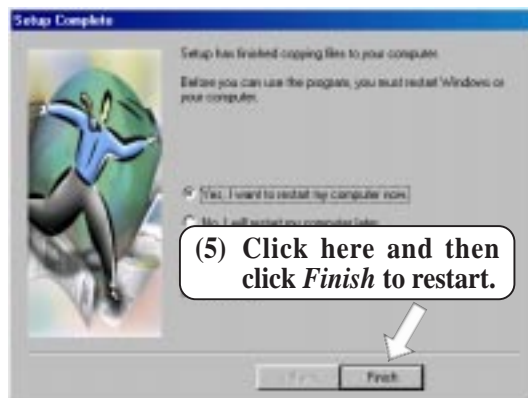
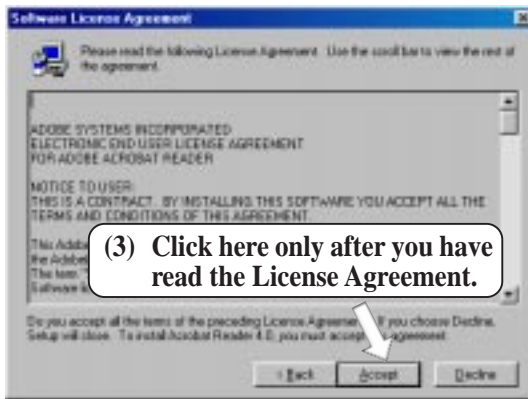

# 5. SOFTWARE SETUP

## 5.9 Uninstalling Programs

Add/Remove Programs is a basic component within Windows. You may use this function if a program does not provide its own uninstallation program.

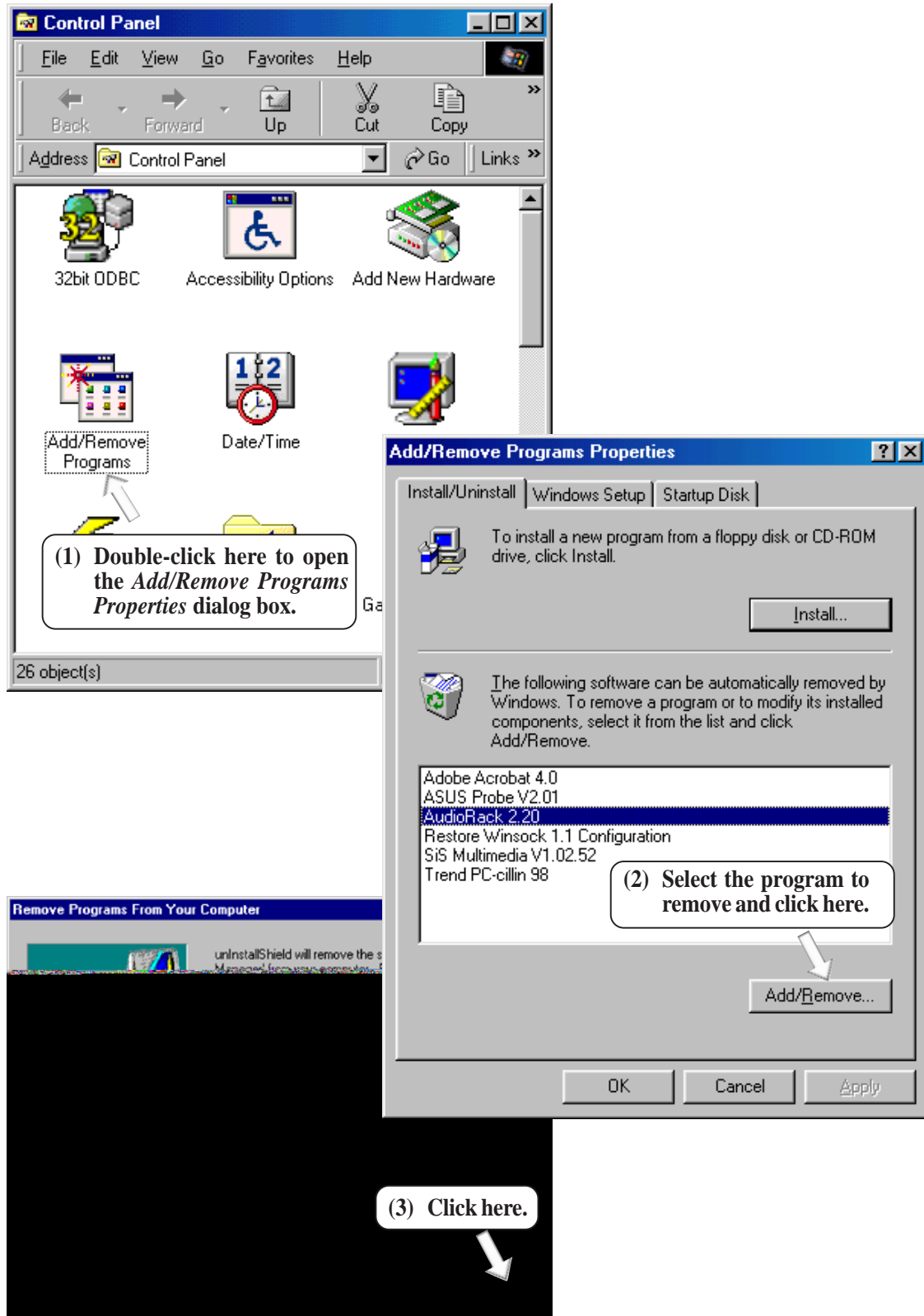



# 6. SOFTWARE REFERENCE

## 6.1 Intel LANDesk Client Manager

With the growth of the computer industry, computer systems have become more complex and difficult to manage. Intel LANDesk Client Manager is a computer management application that simplifies many aspects of managing a computer and assists in troubleshooting common computer problems.

Use Client Manager to:

- Review system inventory
- View DMI-compliant component information
- Backup and restore system files
- Troubleshoot
- Monitor your computer's health
- Receive notifications for system events

Client Manager has been implemented in two different ways:

The client version enables you to view information and manage alerts for a local computer. This version does not permit you to select remote computers, transfer files, or reboot other computers.

The first time you run Client Manager, it searches your network for other computers running Client Manager. Client Manager creates a list of the computers it finds and saves the list to the Windows registry. From this point on, when you run Client Manager or open the Select Computer dialog box, Client Manager checks to see if these computers (listed in the registry) are available and healthy.



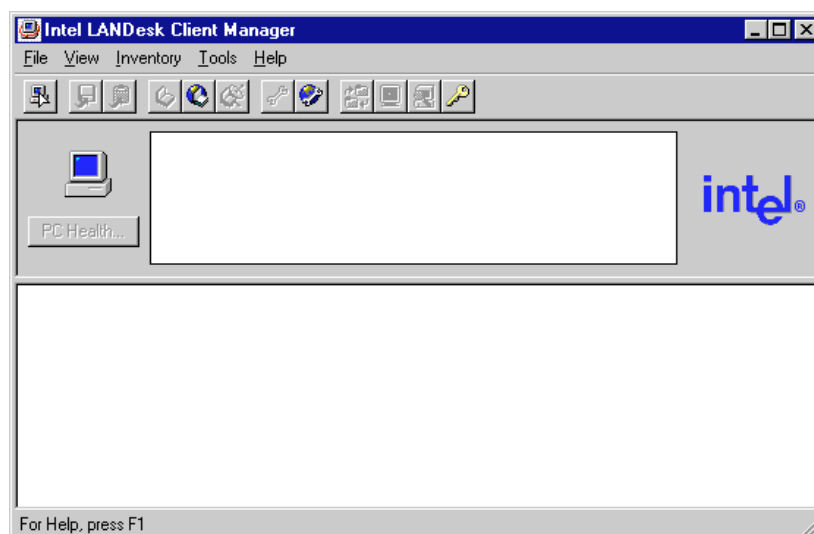



### 6.1.1 Main Client Manager Window



# 6. SOFTWARE REFERENCE

## 6.1.2 Using the Taskbar icons







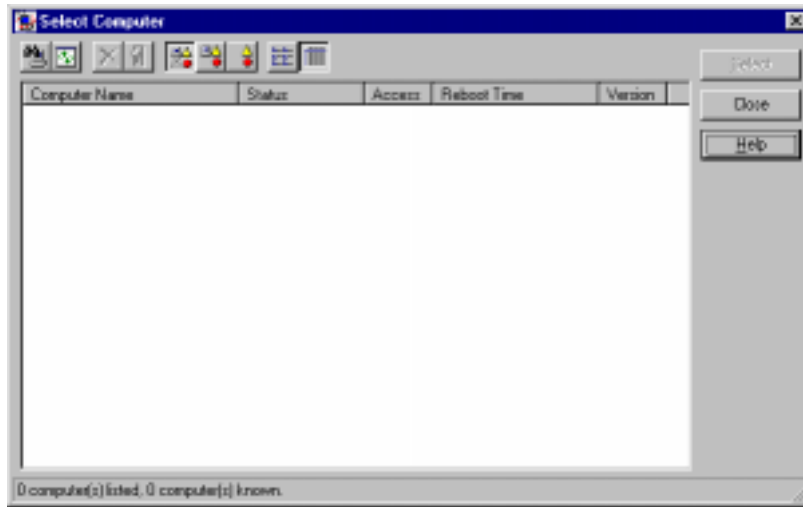

### *Toolbar Descriptions*

	Opens the Select Computer dialog box	File   Select Computer
	Opens the Export dialog box to export the inventory to a file	File   Export
	Exports the inventory to the clipboard	File   Export to clipboard
	Opens the notification log	View   Notification Log
	Opens the global notification log	View   Global Notification Log
	Opens the remote access log	View   Remote Access Log
	Opens the Configure Notifications dialog box	Tools   Configure Notifications
	Opens the Configure Global Notifications dialog box	Tools   Configure Global
	Opens the File Transfer dialog box	Tools   Transfer Files
	Reboots the computer	Tools   Reboot
	Opens the DMI Explorer	Tools   DMI Explorer
	Opens the Set Access Rights dialog box	Tools   Set Access Rights

# 6. SOFTWARE REFERENCE

## 6.1.3 Using the Select Computer Dialog Box



-  Discovers new computers on the network
-  Refreshes the health of known computers
-  Removes a computer from the list of discovered computers
-  Wakes up a sleeping computer
-  Shows all discovered computers
-  Shows only available computers
-  Shows only unhealthy computers
-  Shows a simple list view
-  Shows a detailed list view

## 6. SOFTWARE REFERENCE

---

### 6.1.4 To select a computer

1. From the main Client Manager window, click **File | Select Computer**.
2. In the *Select Computer* dialog box, click the computer you want to view.
3. Click the **Select** button.

### 6.1.5 To discover new computers

- In the *Select Computer* dialog box, click the **Discover** button on the toolbar or press <Shift>+<F5>.

**TIP:** Use the **Discover** button each time you add a computer to the network, change a computer's network adapter, or upgrade a computer to a newer version Client Manager.

### 6.1.6 To refresh PC health

- In the *Select Computer* dialog box, click the **Refresh Known Computers** button on the toolbar or press <F5>.

**TIP:** PC health does not automatically update as changes occur. For example, if a computer's health changes while you are displaying the *Select Computer* dialog box, you need to refresh the list in order to view the correct PC health.

### 6.1.7 To remove a computer from the list

1. In the *Select Computer* dialog box, click the computer name you want to remove.
2. Click the **Remove Computer** button on the toolbar or press Delete.
3. At the prompt, click the **Yes** button.

**TIP:** Perform this task each time you remove a computer from the network, since the name of that computer is not automatically removed from this list.

### 6.1.8 To wake up a computer

1. In the *Select Computer* dialog box, click the computer name you want to wake up. You can also <Shift>+click to select a continuous group of computers or <Ctrl>+click to select individual computers in the list.

**TIP:** You can only attempt to wake up computers that have a status of Unavailable or Wakeable. If the *Select Computer* dialog box does not display any computers with a status of Unavailable or Wakeable and you suspect it should, the list view may be filtered to display only unhealthy or available computers. You may need to change your list view to display all computers.

2. Click the **Wake Up Computer** button on the toolbar to wake up the selected computer(s) or press <Alt>+<W>.

## 6. SOFTWARE REFERENCE

---

After you attempt to wake up a computer, the status of that computer changes in the list view to a Wake Pending status. If the attempt to wake up a computer is successful, the Wake Pending status changes to a status reflecting the computer's health (such as Normal, Warning, or Critical). If the computer does not wake up after five minutes, a message box appears stating possible reasons why the computer did not respond. (For example, the computer may be disabled or may not support Wake-On-LAN.) After clicking OK, the Wake Pending status reverts to its original status of Unavailable or Wakeable.

**NOTE:** Your computer must have a Wake-On-LAN network adapter to support this feature. Some computers that support the Wake-On-LAN technology may have remote wakeup disabled in the BIOS by default. Before Client Manager can wake up a remote computer, you will need to enable this option in the BIOS configuration of each remote computer.









### 6.1.9 Displaying the Properties of a Client Computer

You can display the properties of any discovered client computer even if you cannot otherwise access the computer because of access limitations or Unavailable status. If you display the properties of an unavailable computer, the properties are read from a database in the Windows registry on your computer. Since the Operating System information is not stored in this same database, that information is not available for a computer with a status of Unavailable. Remember that some items may not be current if the properties have changed while the computer was off the network.

## 6. SOFTWARE REFERENCE

### 6.1.10 Understanding the Computer Status Icons

When you open the Select Computer dialog box, each computer in the list displays an icon indicating the current status of that computer. The table below describes the seven states a computer may be in.

	<b>Unavailable</b>	The computer is currently in a powered-down state.
	<b>Wakeable</b>	The computer is currently in a powered-down state but supports Remote Wakeup technology.
	<b>Wake Pending</b>	A temporary status (not to exceed five minutes) while Client Manager attempts to wake up a computer. (A computer that is in the process of booting without having received a wakeup instruction is listed as <i>Unavailable</i> , not <i>Wake Pending</i> .)
	<b>Normal</b>	The computer is operating within normal tolerances.
	<b>Warning</b>	A computer that has exceeded a warning tolerance level. For example, the PC Health indicator can be configured to display a warning icon if a hard disk is running low on space.
	<b>Critical</b>	A computer that has exceeded a critical tolerance level. For example, if the hard disk is running critically low on available space, the PC Health indicator displays a critical icon.
	<b>Unknown</b>	A computer that is powered on, but the health status (Normal, Warning, or Critical) is not known.
	<b>Normal (Mobile)</b>	A computer that includes support for mobile PC features, such as mobile battery. Mobile computers display the same array of health icons (above) used for non-mobile computers.

## 6. SOFTWARE REFERENCE

### 6.2 ASUS PC Probe

ASUS PC Probe is a convenient utility to continuously monitor your computer system's vital components, such as fan rotations, voltages, and temperatures. It also has a utility that lets you review useful information about your computer, such as hard disk space, memory usage, and CPU type, CPU speed, and internal/external frequencies through the DMI Explorer.

#### 6.2.1 Starting ASUS PC Probe

When ASUS PC Probe starts, a splash screen appears allowing you to select whether to show the screen again when you open PC Probe or not. To bypass this startup screen, clear the **Show up in next execution** check box.

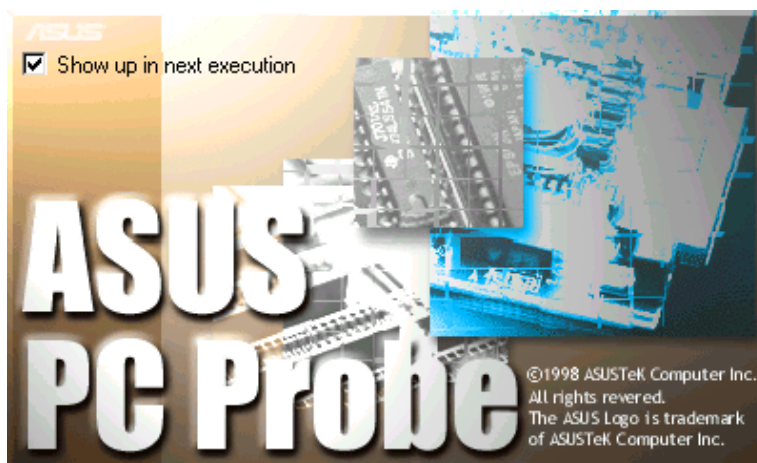

To open **ASUS PC Probe**, click the Windows **Start** button, point to **Programs**, and then **ASUS Utility**, and then click **Probe Vx.xx**.

The PC Probe icon  will appear on the taskbar's system tray indicating that ASUS PC Probe is running. Clicking the icon will allow you to see the status of your PC.





# 6. SOFTWARE REFERENCE

## 6.2.2 Using ASUS PC Probe

### Monitoring

#### Monitor Summary

Shows a summary of the items being monitored.



#### Temperature Monitor

Shows the PC's temperature.

Temperature Warning threshold adjustment  
(Move the slider up to increase the threshold level or down to decrease the threshold level)

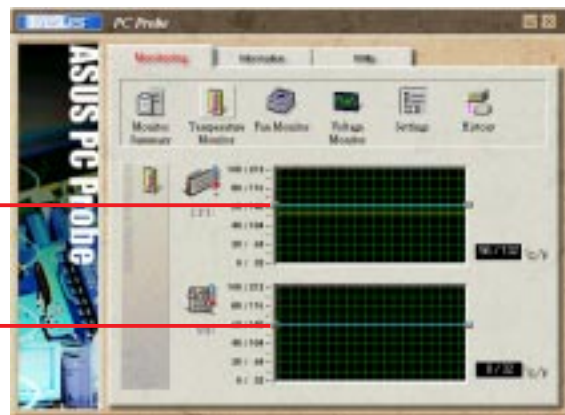

#### Fan Monitor

Shows the PC's fan rotation.

Fan Warning threshold adjustment  
(Move the slider up to increase the threshold level or down to decrease the threshold level)

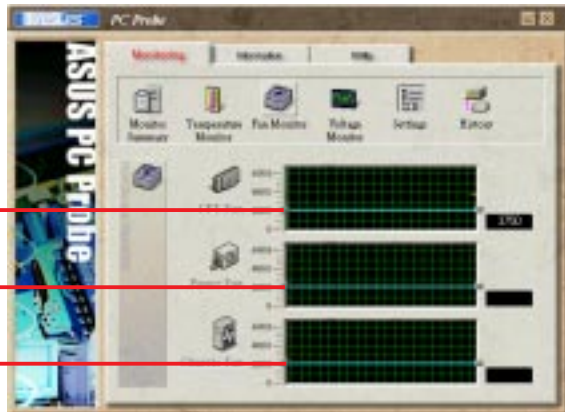

#### Voltage Monitor

Shows the PC's voltages.

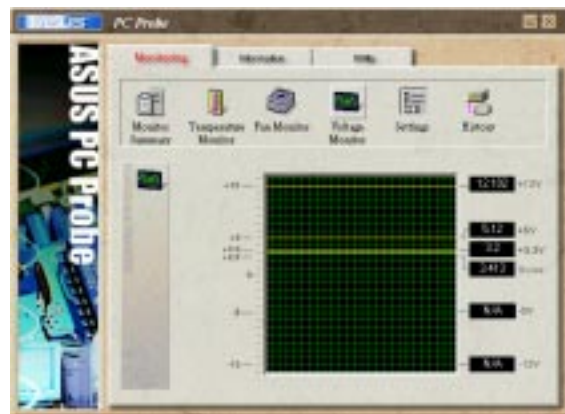



# 6. SOFTWARE REFERENCE

## Settings

Lets you set threshold levels and polling intervals or refresh times of the PC's temperature, fan rotation, and voltages.



## History

Lets you record the monitoring activity of a certain component of your PC by date, time, and target history.



## Information

### Hard Drives

Shows the used and free space of the PC's hard disk drives and the file allocation table or file system used.



### Memory

Shows the PC's memory load, memory usage, and paging file usage.



# 6. SOFTWARE REFERENCE

## Device Summary

Shows a summary of devices in your PC.



## DMI Explorer

Shows information pertinent to the PC, such as CPU type, CPU speed, and internal/external frequencies, and memory size.



## Utility

Lets you run programs outside of the ASUS Probe modules. To run a program, click **Execute Program**. **NOTE:** This feature is currently unavailable.



## 6. SOFTWARE REFERENCE

### 6.2.3 ASUS PC Probe Task Bar Icon

Right clicking the PC Probe icon will bring up a menu to open or exit ASUS PC Probe and pause or resume all system monitoring.

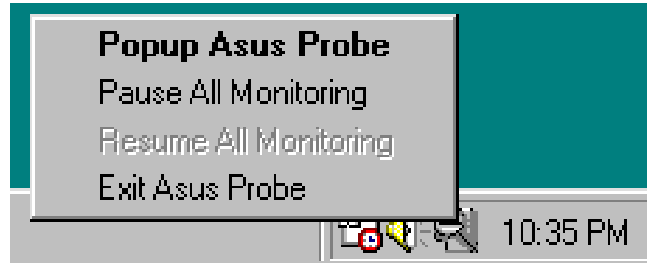

When the ASUS PC Probe senses a problem with your PC, portions of the ASUS PC Probe icon changes to red, the PC speaker beeps, and the ASUS PC Probe monitor is displayed.

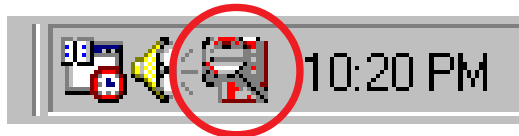

## 6. SOFTWARE REFERENCE

---

(This page was intentionally left blank.)

# 7. APPENDIX

## 7.1 PCI-L101 Fast Ethernet Card

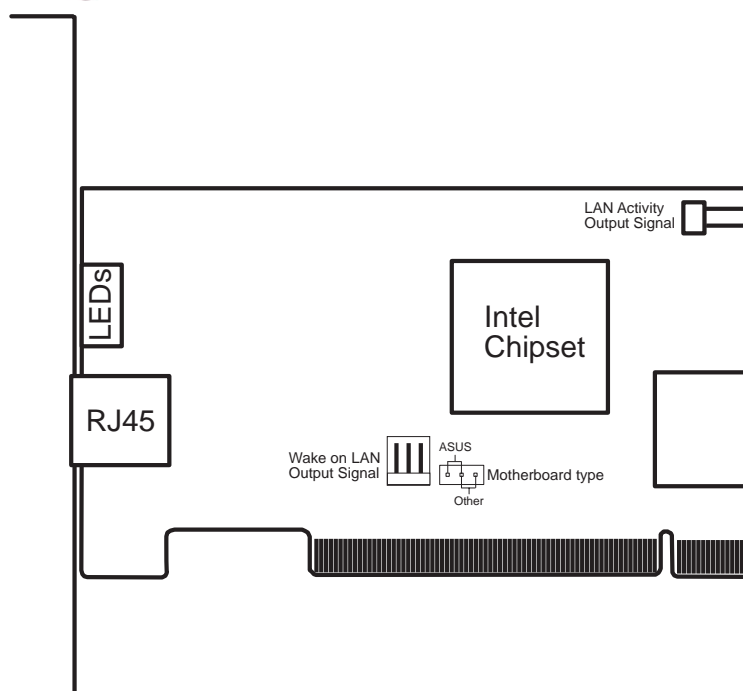
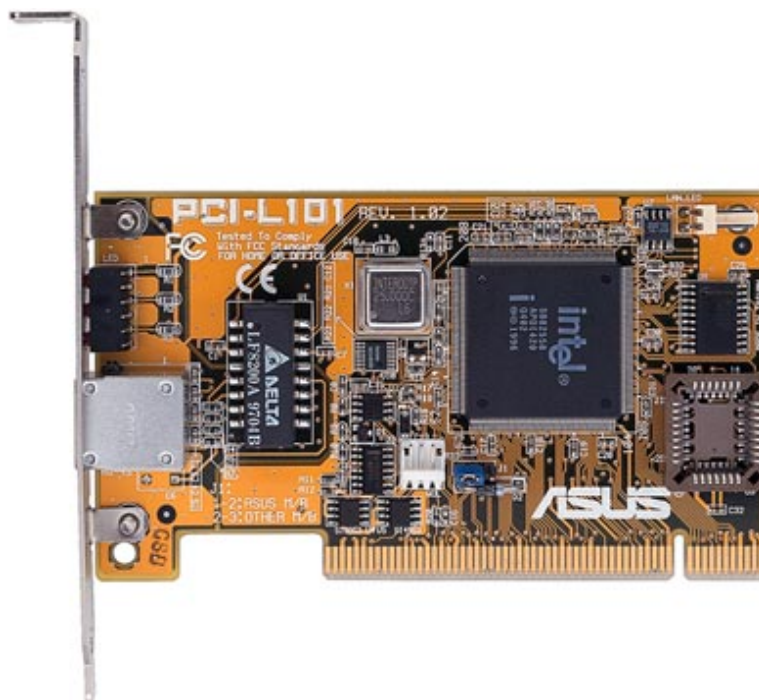

If you are using the ASUS PCI-L101 on an ASUS motherboard, leave the jumper on its default setting of “ASUS.” If you are using another brand of motherboard, set the jumper to “Other.” Connect the Wake on LAN (WOL) output signal to the motherboard’s WOL\_CON in order to utilize the wake on LAN feature of the motherboard. Connect the LAN activity output signal (LAN\_LED) to the system cabinet’s front panel LAN\_LED in order to display the LAN data activity.

7. APPENDIX  
ASUS LAN Card

# 7. APPENDIX

---

## 7.1.1 Features

- Intel 82558 Ethernet LAN Controller (Fully integrated 10BASE-T/100BASE-TX)
- Wake-On-LAN Remote Control Function Supported
- PCI Bus Master Complies to PCI Local Bus Rev. 2.1 specifications
- Consists of MAC & PHY (10/100Mbps) interfaces
- Complies to IEEE 802.3 10BASE-T and IEEE 802.3u 100BASE-TX interfaces
- Fully supports 10BASE-T & 100BASE-TX operations through a single RJ45 port
- Supports 32-bit Bus Master Technology / PCI Rev. 2.1
- Enhancements on ACPI & APM
- Adheres to PCI Bus Power Management Interface Rev. 1.0, ACPI Rev. 1.0, and Device Class Power Management Rev. 1.0
- IEEE 802.3u auto-negotiation for 10Mbps/100Mbps Network Data Transfer Rates.
- Provides LED indicators for monitoring network conditions
- Plug and Play

## 7.1.2 Software Driver Support

- **NetWare ODI Drivers** - Novell Netware 3.x, 4.x, DOS, OS/2 Client
- **NDIS 2.01 Drivers** - Microsoft LAN Manager, Microsoft Windows 3.11, IBM LAN Server
- **NDIS 3.0 Drivers** - Microsoft Windows NT, Microsoft Windows 95, Microsoft Windows 3.11

## 7.1.3 Question and Answer

Q: What is Wake-On-LAN ?

A: The Wake-On-LAN feature provides the capability to remotely power on systems supporting Wake-On-LAN by simply sending a wake-up frame. With this feature, remotely uploading/downloading data to/from systems during off-peak hours will be feasible.

Q: What can Wake-On-LAN do for you ?

A: Wake-On-LAN is a remote management tool with advantages that can reduce system management workload, provide flexibility to the system administrator's job, and then of course save you time-consuming efforts and costs.

Q: What components does Wake-On-LAN require to be enable?

A: To enable Wake-On-LAN function, your system requires Ethernet LAN adapter card that can activate Wake-On-LAN function, a client with Wake-On-LAN capability, and software such as LDCM Rev. 3.10 or up that can trigger wake-up frame.



# 7. APPENDIX

## 7.2 S370 Series CPU Transform Card

The optional ASUS S370 Series CPU cards (S370-D, S370-L, S370) allow Slot 1 motherboards to accept socket 370 processors. The ASUS S370 Series CPU cards give Slot 1 motherboard owners an inexpensive way to upgrade their Pentium II computers using lower costing socket 370 processors. Since socket 370 processors are based on the Pentium II design, the only difference is the connector and the amount of internal cache within the processor.

The following picture shows the ASUS S370 CPU card with a plastic retainer attached to the edge. The retainer is used to hold the ASUS S370 CPU card in place using the motherboard's Slot 1 retention mechanism.

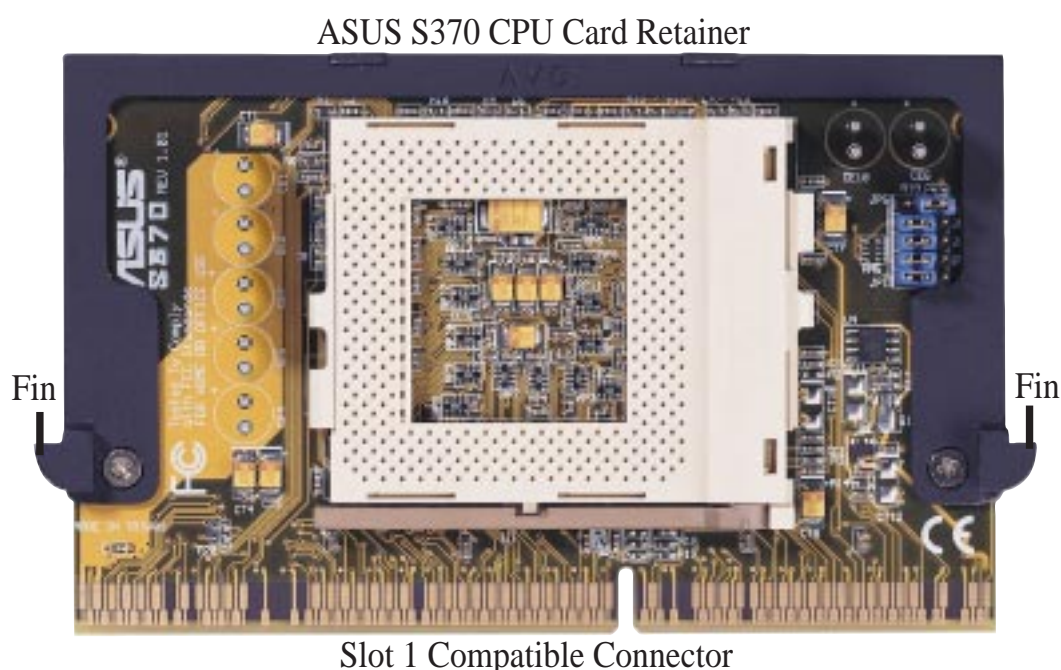

### 7.2.1 Using the ASUS S370

The general procedure for using the ASUS S370 CPU card:

1. Check the voltage setting for your socket 370 processor using the jumpers on the card if necessary. For current socket 370 processors, the default setting should be used. See the reverse side of the ASUS S370 CPU card or the next page for voltage settings.
2. Install the socket 370 processor. Installation of socket 370 processors is exactly like socket 7 processors. Lift the brown lever to 90° to install the processor and lower the brown lever to lock the processor.
3. Insert the ASUS S370 CPU card into Slot 1 on the motherboard. The two fins on the sides of the ASUS S370 CPU card must catch on the retention mechanism so that it locks in place.
4. Connect the socket 370 processor's fan connector to the motherboard.
5. Make sure that no wires or objects come in contact with the fan.

# 7. APPENDIX

## 7.2.2 Setting up the ASUS S370 CPU transform card

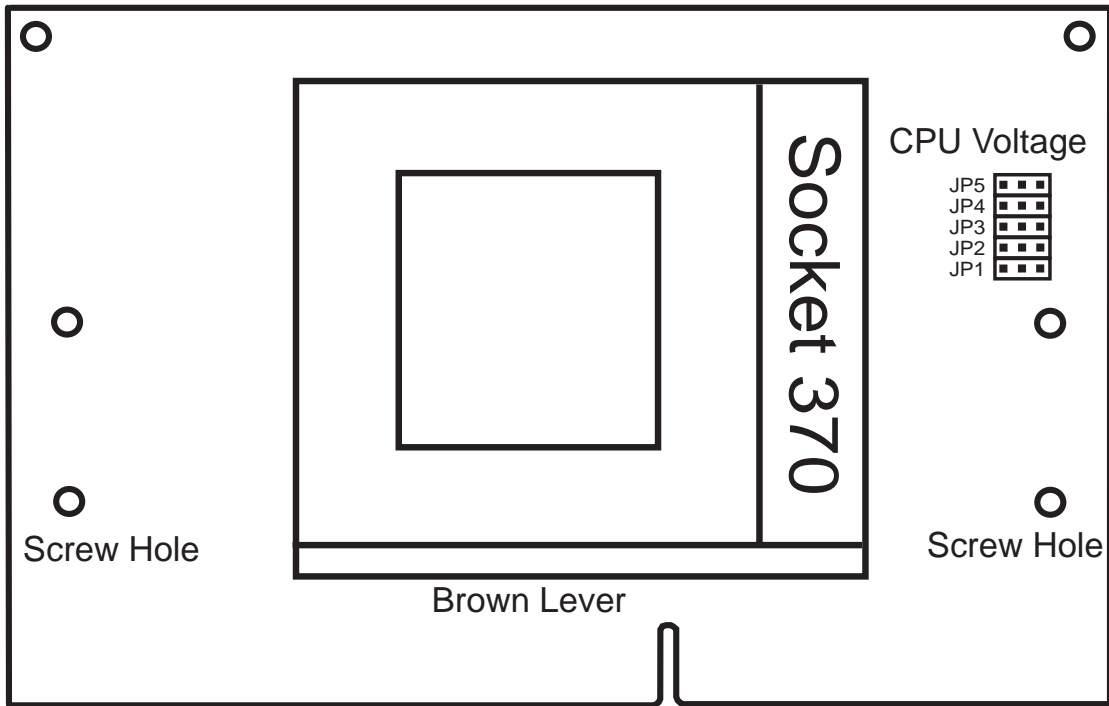

## 7.2.3 ASUS S370 Jumper Settings

Setting the CPU voltage is *not* necessary for current socket 370 processors. If required, your socket 370 processor should have its voltage requirement printed on its surface or documentation. If no voltage is indicated or you are not sure, use the "CPU Def." setting as shown below.

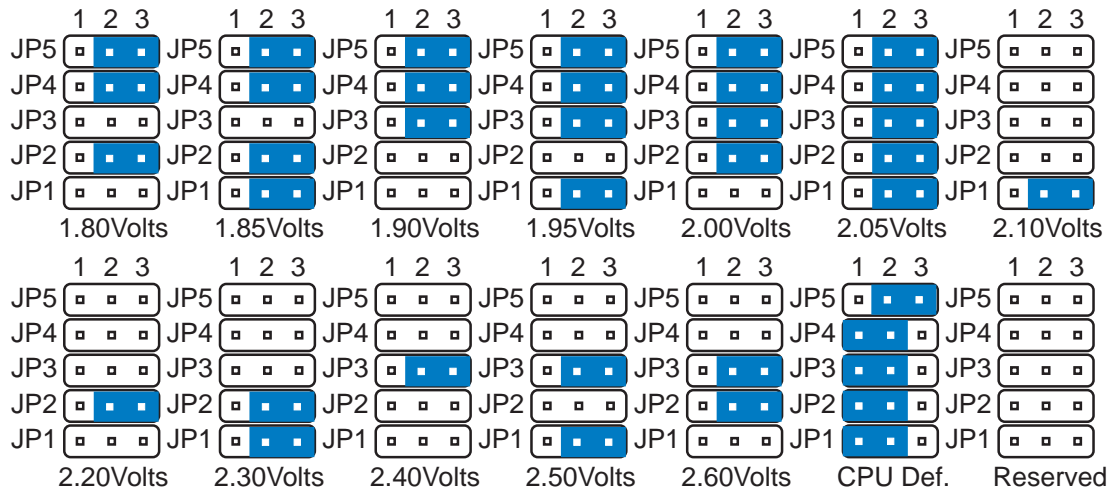

Socket 370 CPU Voltage

**WARNING!** Exceeding your socket 370 processor's required voltage can damage your processor permanently! Make sure that the jumpers are as shown for "CPU Def." unless otherwise specified before powering on your motherboard.